

# **SAWS - FOR ALL MATERIALS**

WORLD ASSOCIATION OF TECHNOLOGY TEACHERS <https://www.facebook.com/groups/254963448192823/> [www.technologystudent.com](http://www.technologystudent.com) © 2022 V.Ryan © 2022

TO ANSWER ALL THE QUESTIONS YOU WILL NEED TO  
DOWNLOAD THE “ SAWS - FOR ALL MATERIALS” APP, FROM  
THE INTERACTIVE MOBILE APP SECTION OF  
[www.technologystudent.com](http://www.technologystudent.com)

**CLICK ON THE  
BUTTON  
TO DOWNLOAD  
THE APP**

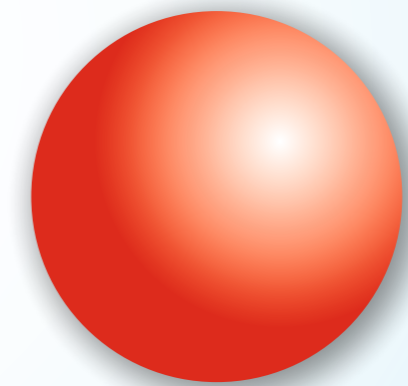

Once you have downloaded the App, you can use it to navigate the website. You may need to follow the links on each page of the App, to research / complete answers to all the questions.

IF YOU ARE AN EDUCATOR, CONSIDER JOINING US AT FACEBOOK – WORLD ASSOCIATION OF TECHNOLOGY TEACHERS

<https://www.facebook.com/groups/254963448192823/>



## WORKSHOP SAWS

TO ANSWER ALL THE QUESTIONS YOU WILL NEED TO DOWNLOAD THE 'SAWS - FOR ALL MATERIALS' APP, FROM THE INTERACTIVE MOBILE APP SECTION OF [www.technologystudent.com](http://www.technologystudent.com)

### LINK

<https://technologystudent.com/mobapps/saws1.pdf>

Once you have downloaded the App, you can use it to navigate the website. You may need to follow the links on each page of the App, to research / complete answers to all the questions.

**ARE YOU READY?  
USE THE MOBILE App!!**

1

BRIEFLY DESCRIBE, THE TWO COMMON BACK SAWS USED IN WORKSHOPS.

NAME: TENON SAW

NAME: DOVETAIL SAW

DESCRIPTION:

DESCRIPTION:

2

PASTE AN IMAGE OF BOTH SAWS, WHICH SHOWS THE RELATIVE SIZE OF EACH ONE.  
You can sketch the saws, if you prefer.

3

WITH THE AID OF A SKETCH(S), DESCRIBE HOW ONE OF THESE SAWS, IS HELD IN THE HAND AND USED.

HELPFUL LINK:

<https://technologystudent.com/mobapps/saws1.pdf>



## WORKSHOP SAWS

TO ANSWER ALL THE QUESTIONS YOU WILL NEED TO DOWNLOAD THE 'SAWS - FOR ALL MATERIALS' APP, FROM THE INTERACTIVE MOBILE APP SECTION OF [www.technologystudent.com](http://www.technologystudent.com)

### LINK

<https://technologystudent.com/mobapps/saws1.pdf>

Once you have downloaded the App, you can use it to navigate the website. You may need to follow the links on each page of the App, to research / complete answers to all the questions.

**ARE YOU READY?  
USE THE MOBILE App!!**

1

BRIEFLY DESCRIBE A RIPSAW. YOU MAY WISH TO REFER TO THE DIAGRAM.

---

---

---

---

---

---

---

---

---

---

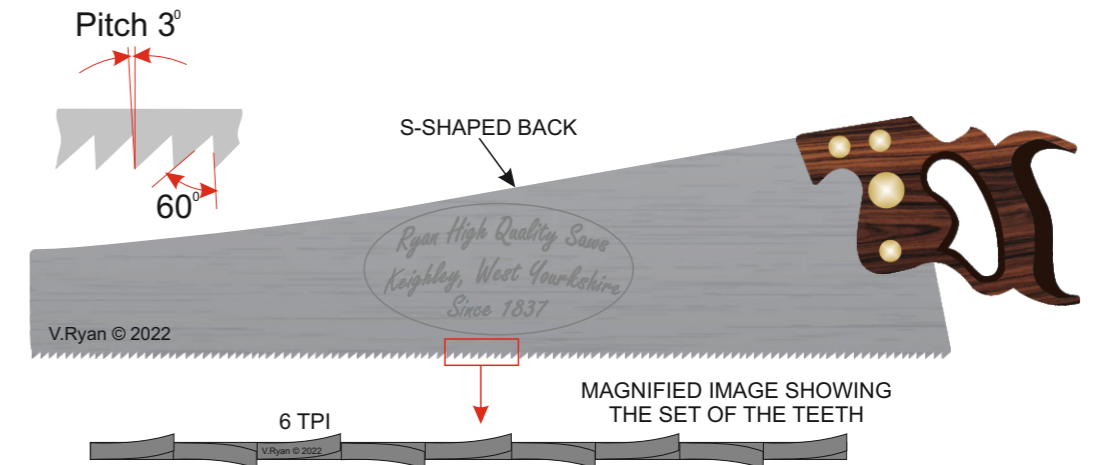

2

WITH THE AID OF A SKETCH / SKETCHES, DESCRIBE RIPSAWING.  
You can paste images if you prefer.

---

---

---

---

---

---

---

---

---

---

HELPFUL LINK:

<https://technologystudent.com/mobapps/saws1.pdf>



## WORKSHOP SAWS

TO ANSWER ALL THE QUESTIONS YOU WILL NEED TO DOWNLOAD THE 'SAWS - FOR ALL MATERIALS' APP, FROM THE INTERACTIVE MOBILE APP SECTION OF [www.technologystudent.com](http://www.technologystudent.com)

### LINK

<https://technologystudent.com/mobapps/saws1.pdf>

Once you have downloaded the App, you can use it to navigate the website. You may need to follow the links on each page of the App, to research / complete answers to all the questions.

**ARE YOU READY?  
USE THE MOBILE App!!**

1

BRIEFLY DESCRIBE A CROSSCUT SAW. YOU MAY WISH TO REFER TO THE DIAGRAM.

---

---

---

---

---

---

---

---

---

---

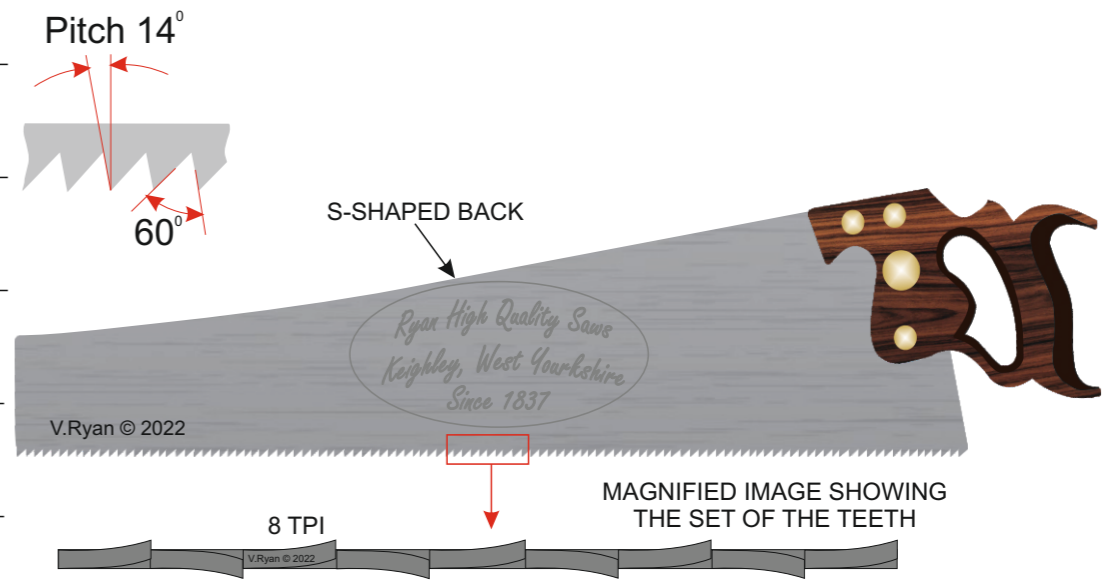

2

WITH THE AID OF A SKETCH / SKETCHES, DESCRIBE CROSS CUTTING A LENGTH OF WOOD.  
You can paste images if you prefer.

---

---

---

---

---

---

---

---

---

---

HELPFUL LINK:

<https://technologystudent.com/mobapps/saws1.pdf>



## WORKSHOP SAWS

TO ANSWER ALL THE QUESTIONS YOU WILL NEED TO DOWNLOAD THE 'SAWS - FOR ALL MATERIALS' APP, FROM THE INTERACTIVE MOBILE APP SECTION OF [www.technologystudent.com](http://www.technologystudent.com)

### LINK

<https://technologystudent.com/mobapps/saws1.pdf>

Once you have downloaded the App, you can use it to navigate the website. You may need to follow the links on each page of the App, to research / complete answers to all the questions.

**ARE YOU READY?  
USE THE MOBILE App!!**

1

BRIEFLY DESCRIBE A PANEL SAW. YOU MAY WISH TO REFER TO THE DIAGRAM OF THE SAW.

---

---

---

---

---

---

---

---

---

---

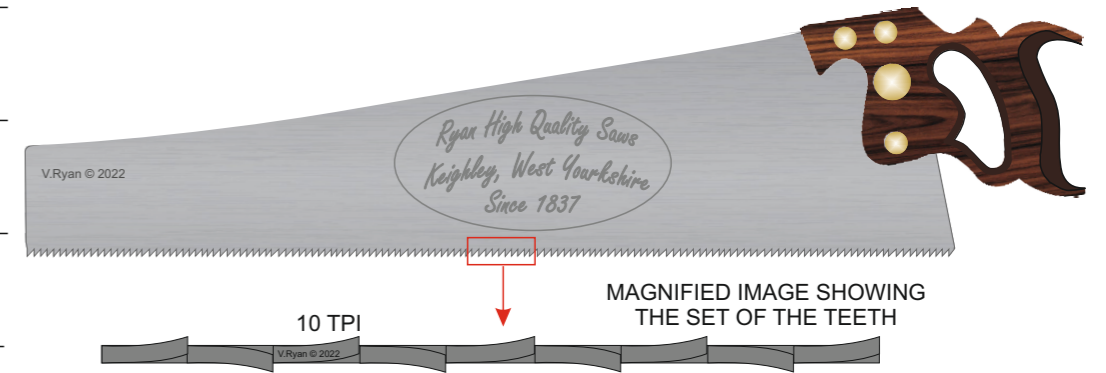

2

WITH THE AID OF A SKETCH / SKETCHES, DESCRIBE THE USE OF A PANEL SAW.  
You can paste images if you prefer.

---

---

---

---

---

---

---

---

---

---

HELPFUL LINK:

<https://technologystudent.com/mobapps/saws1.pdf>



## WORKSHOP SAWS

TO ANSWER ALL THE QUESTIONS YOU WILL NEED TO DOWNLOAD THE 'SAWS - FOR ALL MATERIALS' APP, FROM THE INTERACTIVE MOBILE APP SECTION OF [www.technologystudent.com](http://www.technologystudent.com)

### LINK

<https://technologystudent.com/mobapps/saws1.pdf>

Once you have downloaded the App, you can use it to navigate the website. You may need to follow the links on each page of the App, to research / complete answers to all the questions.

**ARE YOU READY?  
USE THE MOBILE App!!**

1

BRIEFLY DESCRIBE A FRAME SAW. YOU MAY WISH TO REFER TO THE DIAGRAM BELOW.

---



---



---



---



---



---



---



---



2

WITH THE AID OF A SKETCH / SKETCHES, DESCRIBE THE USE OF A FRAME SAW.  
You can paste images if you prefer.

---



---



---



---



---



---



---



---

HELPFUL LINK:

<https://technologystudent.com/mobapps/saws1.pdf>

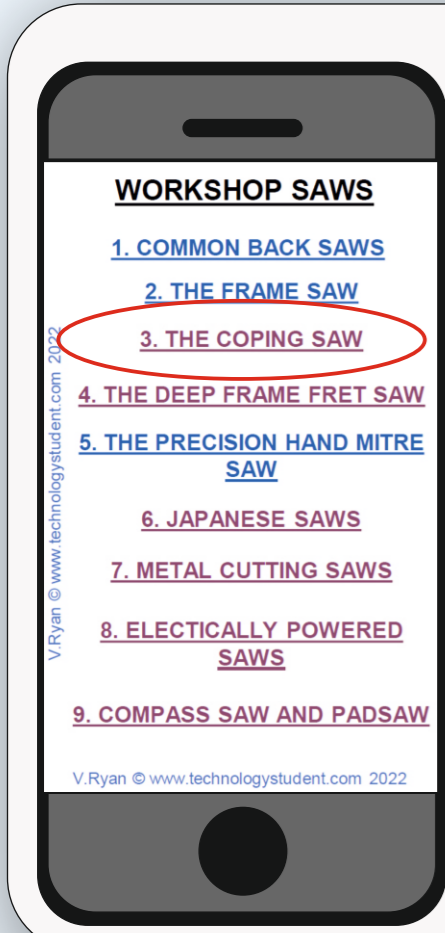

## WORKSHOP SAWS

TO ANSWER ALL THE QUESTIONS YOU WILL NEED TO DOWNLOAD THE 'SAWS - FOR ALL MATERIALS' APP, FROM THE INTERACTIVE MOBILE APP SECTION OF [www.technologystudent.com](http://www.technologystudent.com)

### LINK

<https://technologystudent.com/mobapps/saws1.pdf>

Once you have downloaded the App, you can use it to navigate the website. You may need to follow the links on each page of the App, to research / complete answers to all the questions.

**ARE YOU READY?  
USE THE MOBILE App!!**

1

BRIEFLY DESCRIBE A COPING SAW. EXPLAIN HOW THE BLADE IS CHANGED / REPLACED.

---

---

---

---

---

---

---

---

---

---



2

WITH THE AID OF A SKETCH / SKETCHES, DESCRIBE THE USE OF A COPING SAW.

You can paste images if you prefer.

---

---

---

---

---

---

---

---

---

---

HELPFUL LINK:

<https://technologystudent.com/mobapps/saws1.pdf>



## WORKSHOP SAWS

TO ANSWER ALL THE QUESTIONS YOU WILL NEED TO DOWNLOAD THE 'SAWS - FOR ALL MATERIALS' APP, FROM THE INTERACTIVE MOBILE APP SECTION OF [www.technologystudent.com](http://www.technologystudent.com)

### LINK

<https://technologystudent.com/mobapps/saws1.pdf>

Once you have downloaded the App, you can use it to navigate the website. You may need to follow the links on each page of the App, to research / complete answers to all the questions.

**ARE YOU READY?  
USE THE MOBILE App!!**

1

BRIEFLY DESCRIBE A DEEP FRAME FRET SAW. ADD MORE LABELS TO THE DIAGRAM.

---

---

---

---

---

---

---

---

---

---



2

WITH THE AID OF A SKETCH / SKETCHES, DESCRIBE THE USE OF A DEEP FRAME FRET SAW.  
You can paste images if you prefer.

---

---

---

---

---

---

---

---

---

---

HELPFUL LINK:

<https://technologystudent.com/mobapps/saws1.pdf>





## WORKSHOP SAWS

TO ANSWER ALL THE QUESTIONS YOU WILL NEED TO DOWNLOAD THE 'SAWS - FOR ALL MATERIALS' APP, FROM THE INTERACTIVE MOBILE APP SECTION OF [www.technologystudent.com](http://www.technologystudent.com)

### LINK

<https://technologystudent.com/mobapps/saws1.pdf>

Once you have downloaded the App, you can use it to navigate the website. You may need to follow the links on each page of the App, to research / complete answers to all the questions.

**ARE YOU READY?  
USE THE MOBILE App!!**

1

WHAT ARE THE USES OF A PRECISION HAND MITRE SAW?  
(SEEN OPPOSITE)

---

---

---

---

---

---

---

---

## PRECISION HAND MITRE SAW



2

EXPLAIN THE USE OF THE HAND MITRE SAW, WITH REFERENCE TO THE DIAGRAM BELOW.

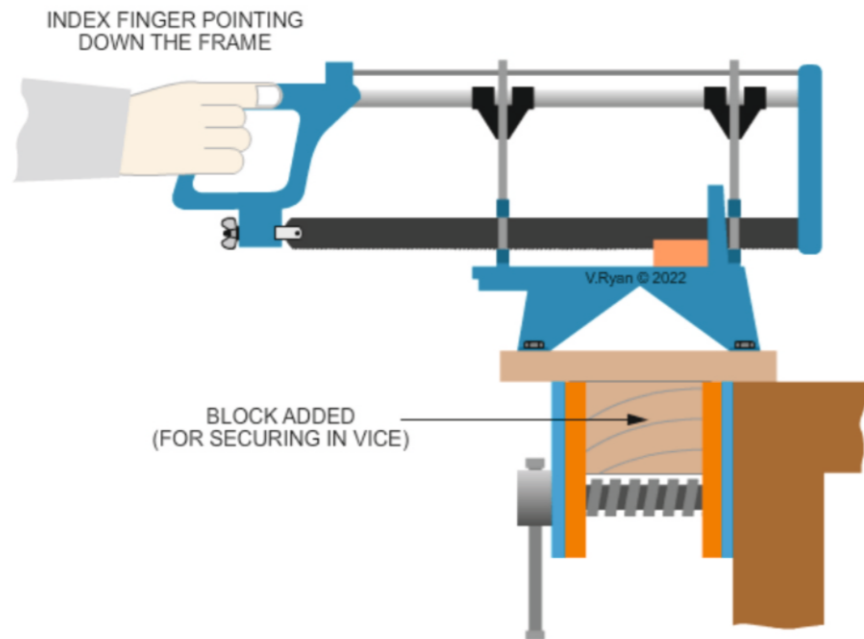

## YOUR EXPLANATION

---

---

---

---

---

---

---

---

3

DESCRIBE TWO ADVANTAGES OF THE MITRE SAW, COMPARED TO OTHER HAND SAWS.

---

---

---

---

---

---

---

---

HELPFUL LINK:

<https://technologystudent.com/mobapps/saws1.pdf>



## WORKSHOP SAWS

TO ANSWER ALL THE QUESTIONS YOU WILL NEED TO DOWNLOAD THE 'SAWS - FOR ALL MATERIALS' APP, FROM THE INTERACTIVE MOBILE APP SECTION OF [www.technologystudent.com](http://www.technologystudent.com)

### LINK

<https://technologystudent.com/mobapps/saws1.pdf>

Once you have downloaded the App, you can use it to navigate the website. You may need to follow the links on each page of the App, to research / complete answers to all the questions.

**ARE YOU READY?  
USE THE MOBILE App!!**

1

BRIEFLY DESCRIBE A KATABA JAPANESE SAW.

---

---

---

---

---

---

---

---



2

WITH THE AID OF A SKETCH / SKETCHES, DESCRIBE THE USE OF A KATABA JAPANESE SAW.  
You can paste images if you prefer.

---

---

---

---

---

---

---

---

HELPFUL LINK:

<https://technologystudent.com/mobapps/saws1.pdf>

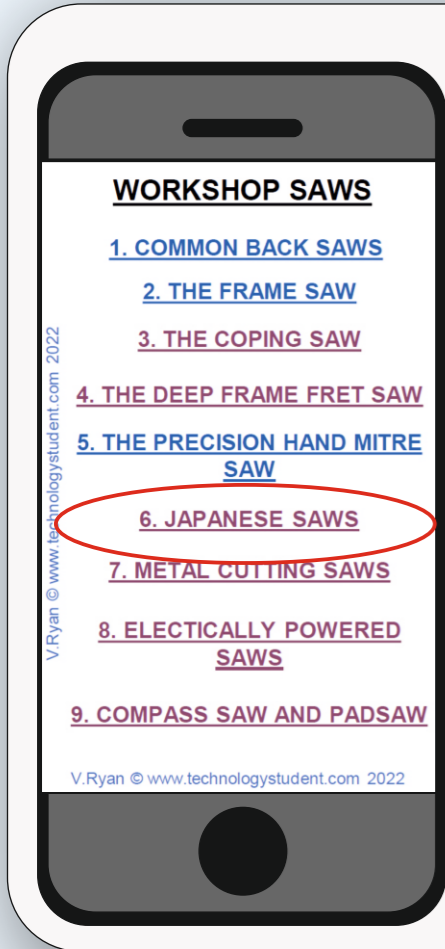

## WORKSHOP SAWS

TO ANSWER ALL THE QUESTIONS YOU WILL NEED TO DOWNLOAD THE 'SAWS - FOR ALL MATERIALS' APP, FROM THE INTERACTIVE MOBILE APP SECTION OF [www.technologystudent.com](http://www.technologystudent.com)

### LINK

<https://technologystudent.com/mobapps/saws1.pdf>

Once you have downloaded the App, you can use it to navigate the website. You may need to follow the links on each page of the App, to research / complete answers to all the questions.

**ARE YOU READY?  
USE THE MOBILE App!!**

1

BRIEFLY DESCRIBE A RYOBA JAPANESE SAW.

---

---

---

---

---

---

---

---

---

---

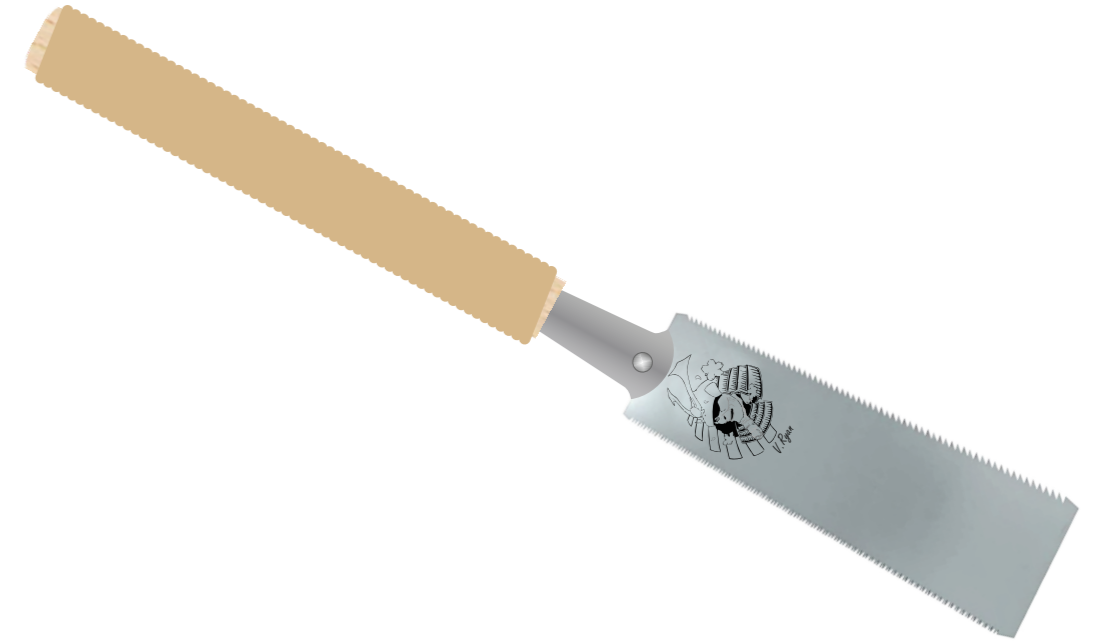

2

WITH THE AID OF A SKETCH / SKETCHES, DESCRIBE THE USE OF A RYOBA JAPANESE SAW.  
You can paste images if you prefer.

---

---

---

---

---

---

---

---

---

---

HELPFUL LINK:

<https://technologystudent.com/mobapps/saws1.pdf>



## WORKSHOP SAWS

TO ANSWER ALL THE QUESTIONS YOU WILL NEED TO DOWNLOAD THE 'SAWS - FOR ALL MATERIALS' APP, FROM THE INTERACTIVE MOBILE APP SECTION OF [www.technologystudent.com](http://www.technologystudent.com)

### LINK

<https://technologystudent.com/mobapps/saws1.pdf>

Once you have downloaded the App, you can use it to navigate the website. You may need to follow the links on each page of the App, to research / complete answers to all the questions.

**ARE YOU READY?  
USE THE MOBILE App!!**

1

BRIEFLY DESCRIBE A DOZUKI JAPANESE SAW.

Make reference to the back / support.

---

---

---

---

---

---

---

---

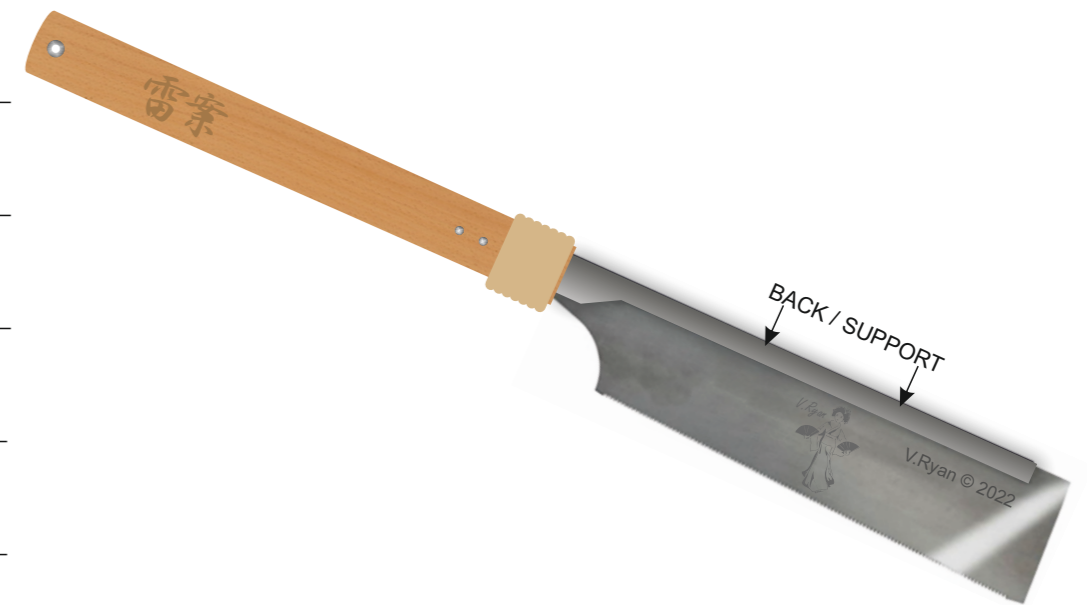

2

WITH THE AID OF A SKETCH / SKETCHES, DESCRIBE THE USE OF A DOZUKI JAPANESE SAW.

You can paste images if you prefer.

---

---

---

---

---

---

---

---

HELPFUL LINK:

<https://technologystudent.com/mobapps/saws1.pdf>

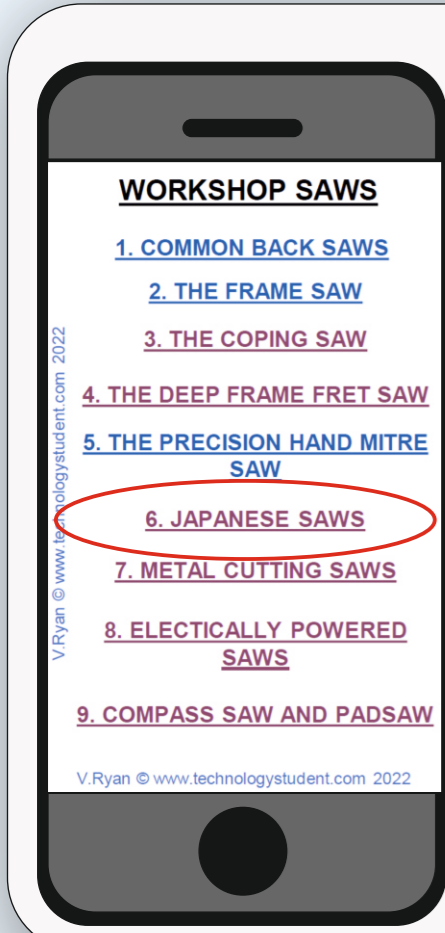

## WORKSHOP SAWS

TO ANSWER ALL THE QUESTIONS YOU WILL NEED TO DOWNLOAD THE 'SAWS - FOR ALL MATERIALS' APP, FROM THE INTERACTIVE MOBILE APP SECTION OF [www.technologystudent.com](http://www.technologystudent.com)

### LINK

<https://technologystudent.com/mobapps/saws1.pdf>

Once you have downloaded the App, you can use it to navigate the website. You may need to follow the links on each page of the App, to research / complete answers to all the questions.

**ARE YOU READY?  
USE THE MOBILE App!!**

1

**BRIEFLY DESCRIBE A MOWASHIBIKI JAPANESE SAW.**

Include a description of its appearance.

---

---

---

---

---

---

---

---

---

---



2

**WITH THE AID OF A SKETCH / SKETCHES, DESCRIBE THE USE OF A MOWASHIBIKI JAPANESE SAW.**

You can paste images if you prefer.

---

---

---

---

---

---

---

---

---

---

HELPFUL LINK:

<https://technologystudent.com/mobapps/saws1.pdf>



## WORKSHOP SAWS

TO ANSWER ALL THE QUESTIONS YOU WILL NEED TO DOWNLOAD THE 'SAWS - FOR ALL MATERIALS' APP, FROM THE INTERACTIVE MOBILE APP SECTION OF [www.technologystudent.com](http://www.technologystudent.com)

### LINK

<https://technologystudent.com/mobapps/saws1.pdf>

Once you have downloaded the App, you can use it to navigate the website. You may need to follow the links on each page of the App, to research / complete answers to all the questions.

**ARE YOU READY?  
USE THE MOBILE App!!**

1

**BRIEFLY DESCRIBE A HACKSAW.  
Name materials it is used to cut.**

---

---

---

---

---

---

---

---

---

---

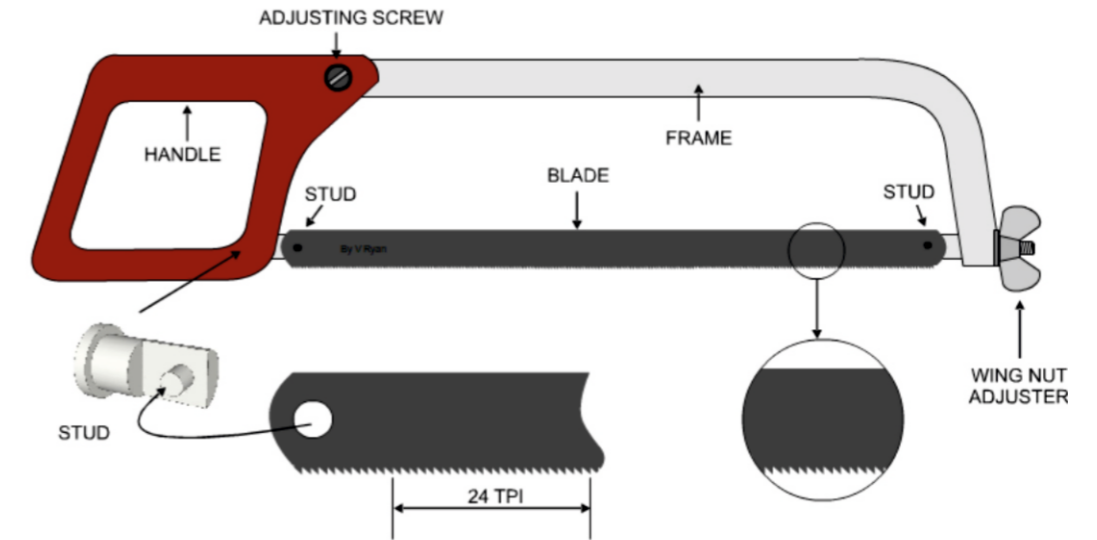

2

**WITH THE AID OF A SKETCH / SKETCHES, DESCRIBE HOW THE HACKSAW IS USED TO CUT METAL TUBE.  
You can paste images if you prefer.**

---

---

---

---

---

---

---

---

---

---

HELPFUL LINK:

<https://technologystudent.com/mobapps/saws1.pdf>



## WORKSHOP SAWS

TO ANSWER ALL THE QUESTIONS YOU WILL NEED TO DOWNLOAD THE 'SAWS - FOR ALL MATERIALS' APP, FROM THE INTERACTIVE MOBILE APP SECTION OF [www.technologystudent.com](http://www.technologystudent.com)

### LINK

<https://technologystudent.com/mobapps/saws1.pdf>

Once you have downloaded the App, you can use it to navigate the website. You may need to follow the links on each page of the App, to research / complete answers to all the questions.

**ARE YOU READY?  
USE THE MOBILE App!!**

1

**BRIEFLY DESCRIBE THE JUNIOR HACKSAW.**  
Explain how the blade is changed.

---

---

---

---

---

---

---

---

---

---

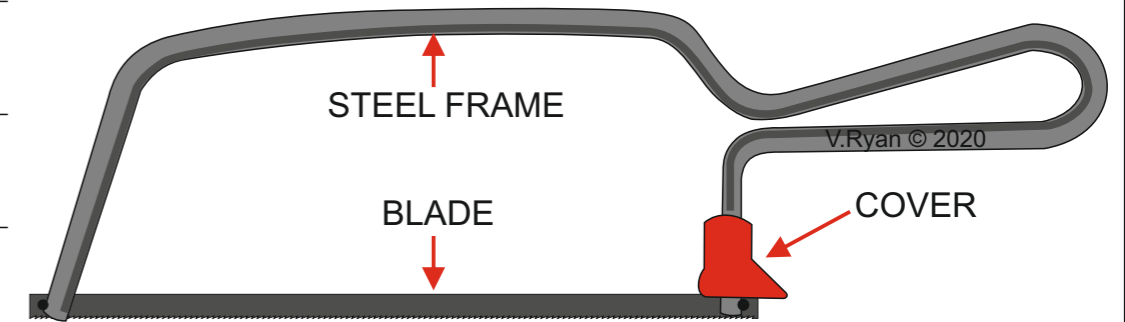

2

**WITH THE AID OF A SKETCH / SKETCHES, DESCRIBE HOW THE JUNIOR HACKSAW IS USED TO CUT METAL TUBE.**  
You can paste images if you prefer.

---

---

---

---

---

---

---

---

---

---

HELPFUL LINK:

<https://technologystudent.com/mobapps/saws1.pdf>



## WORKSHOP SAWS

TO ANSWER ALL THE QUESTIONS YOU WILL NEED TO DOWNLOAD THE 'SAWS - FOR ALL MATERIALS' APP, FROM THE INTERACTIVE MOBILE APP SECTION OF [www.technologystudent.com](http://www.technologystudent.com)

### LINK

<https://technologystudent.com/mobapps/saws1.pdf>

Once you have downloaded the App, you can use it to navigate the website. You may need to follow the links on each page of the App, to research / complete answers to all the questions.

**ARE YOU READY?  
USE THE MOBILE App!!**

1

**BRIEFLY DESCRIBE THE PIERCING SAW (Jeweller's Saw).**  
Explain how the blade is changed.

---

---

---

---

---

---

---

---

---

---

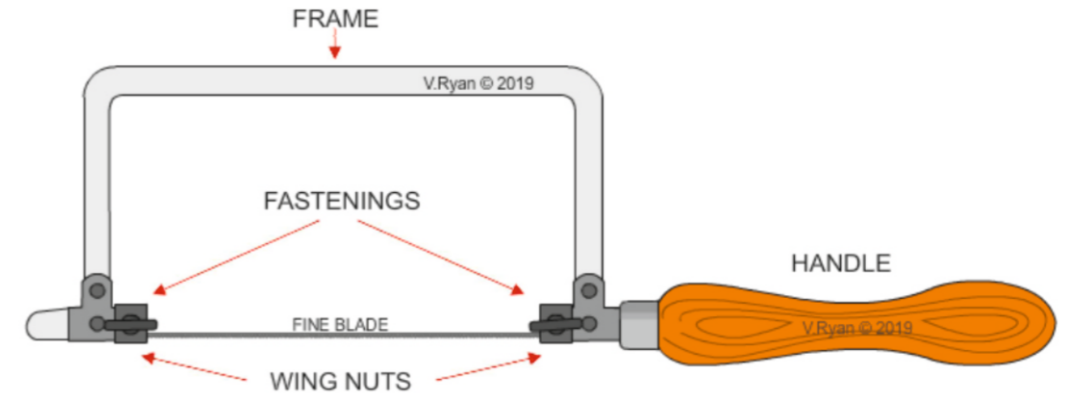

2

**WITH THE AID OF A SKETCH / SKETCHES, DESCRIBE HOW THE PIERCING SAW (Jeweller's Saw) IS USED TO CUT / SHAPE THIN SHEET METAL.**  
You can paste images if you prefer.

---

---

---

---

---

---

---

---

---

---

HELPFUL LINK:

<https://technologystudent.com/mobapps/saws1.pdf>





## WORKSHOP SAWS

TO ANSWER ALL THE QUESTIONS YOU WILL NEED TO DOWNLOAD THE 'SAWS - FOR ALL MATERIALS' APP, FROM THE INTERACTIVE MOBILE APP SECTION OF [www.technologystudent.com](http://www.technologystudent.com)

### LINK

<https://technologystudent.com/mobapps/saws1.pdf>

Once you have downloaded the App, you can use it to navigate the website. You may need to follow the links on each page of the App, to research / complete answers to all the questions.

**ARE YOU READY?  
USE THE MOBILE App!!**

1

WHAT IS A FRETSAW AND WHAT MATERIALS IS IT USED TO CUT / SHAPE?

---

---

---

---

---

---

---

---

---

---

2

DRAW A LABELLED DIAGRAM OF A TYPICAL FRETSAW.

---

---

---

---

---

---

---

---

---

---

3

EXPLAIN / DESCRIBE THE SAFE USE OF THIS FRETSAW.

You may wish to make reference to the diagram below.

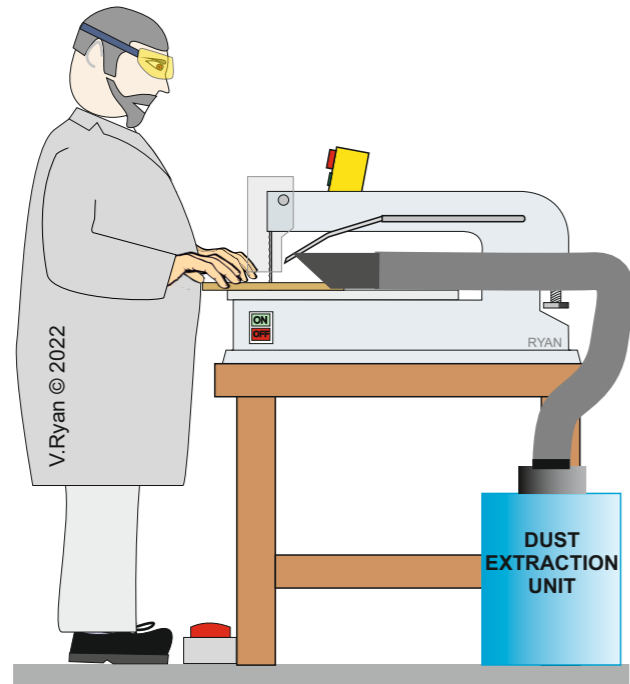

YOUR EXPLANATION - USING A FRETSAW.

---

---

---

---

---

---

---

---

---

---

4

PASTE AN IMAGE OF A FRETSAW BLADE.

Explain the way the teeth should point.

---

---

---

---

---

---

---

---

---

---

HELPFUL LINK:

<https://technologystudent.com/mobapps/saws1.pdf>



### WORKSHOP SAWS

TO ANSWER ALL THE QUESTIONS YOU WILL NEED TO DOWNLOAD THE 'SAWS - FOR ALL MATERIALS' APP, FROM THE INTERACTIVE MOBILE APP SECTION OF [www.technologystudent.com](http://www.technologystudent.com)

**LINK**

<https://technologystudent.com/mobapps/saws1.pdf>

Once you have downloaded the App, you can use it to navigate the website. You may need to follow the links on each page of the App, to research / complete answers to all the questions.

**ARE YOU READY?  
USE THE MOBILE App!!**

**1**

WHAT IS THE FUNCTION OF A BAND SAW? (SEEN OPPOSITE)

---

---

---

---

---

---

---

---

---

---

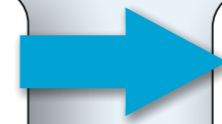

TYPICAL BAND SAW

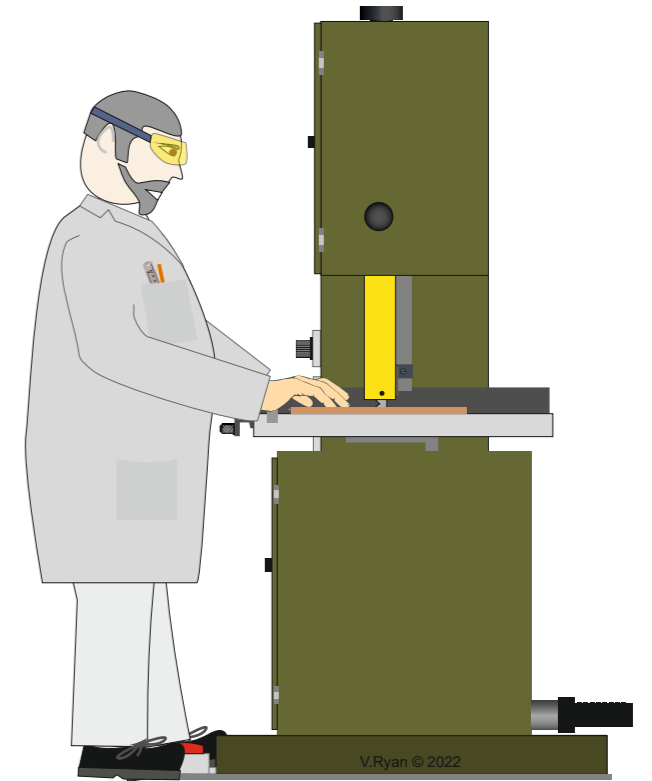

**2**

WHY IS DUST EXTRACTION IMPORTANT?



YOUR EXPLANATION

---

---

---

---

---

---

---

---

---

---

**3**

WHY IS A KEY LOCK VITAL, FOR THIS TYPE OF MACHINE?

---

---

---

---

---

---

---

---

---

---

HELPFUL LINK:

<https://technologystudent.com/mobapps/saws1.pdf>



## WORKSHOP SAWS

TO ANSWER ALL THE QUESTIONS YOU WILL NEED TO DOWNLOAD THE 'SAWS - FOR ALL MATERIALS' APP, FROM THE INTERACTIVE MOBILE APP SECTION OF [www.technologystudent.com](http://www.technologystudent.com)

### LINK

<https://technologystudent.com/mobapps/saws1.pdf>

Once you have downloaded the App, you can use it to navigate the website. You may need to follow the links on each page of the App, to research / complete answers to all the questions.

**ARE YOU READY?  
USE THE MOBILE App!!**

**1** DESCRIBE A HAND HELD JIGSAW AND ITS TYPICAL USE. (JIGSAW SHOWN OPPOSITE)

---

---

---

---

---

---

---

---

---

---

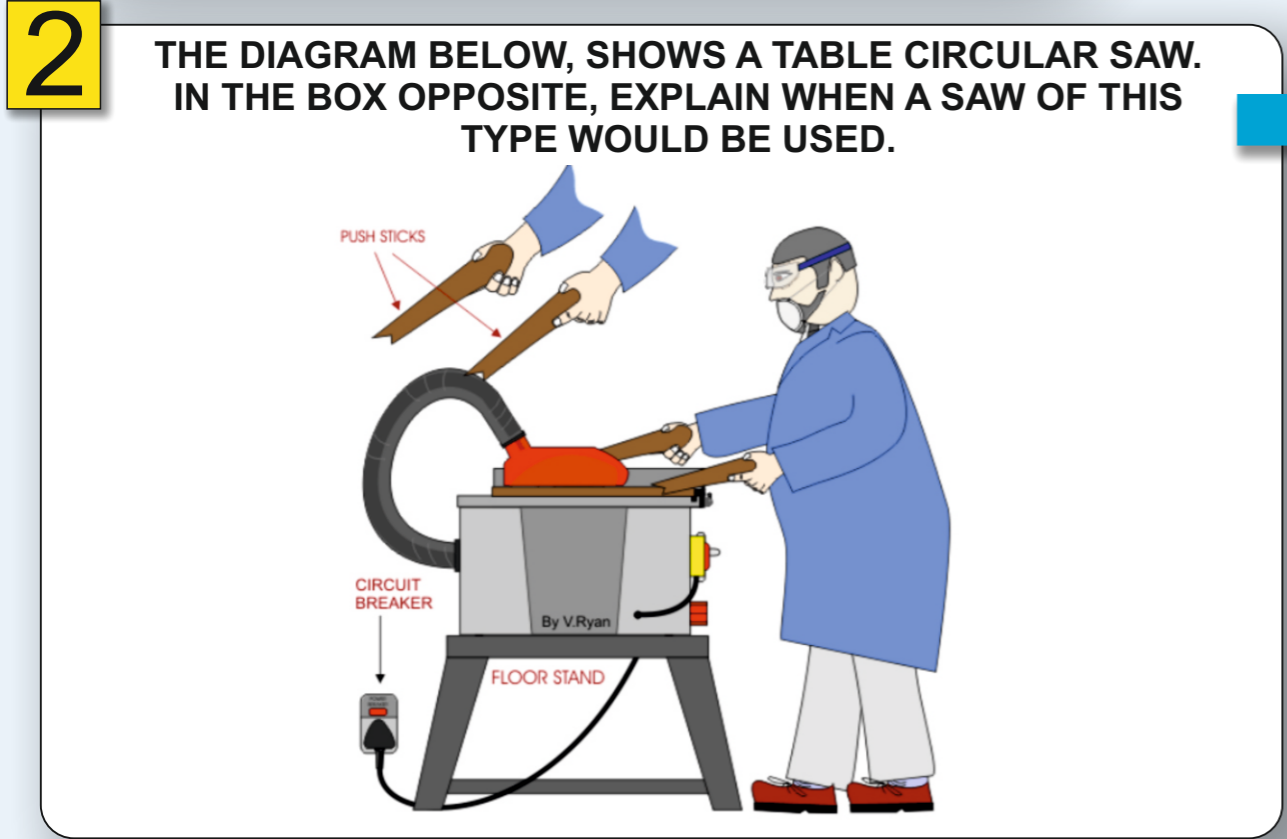
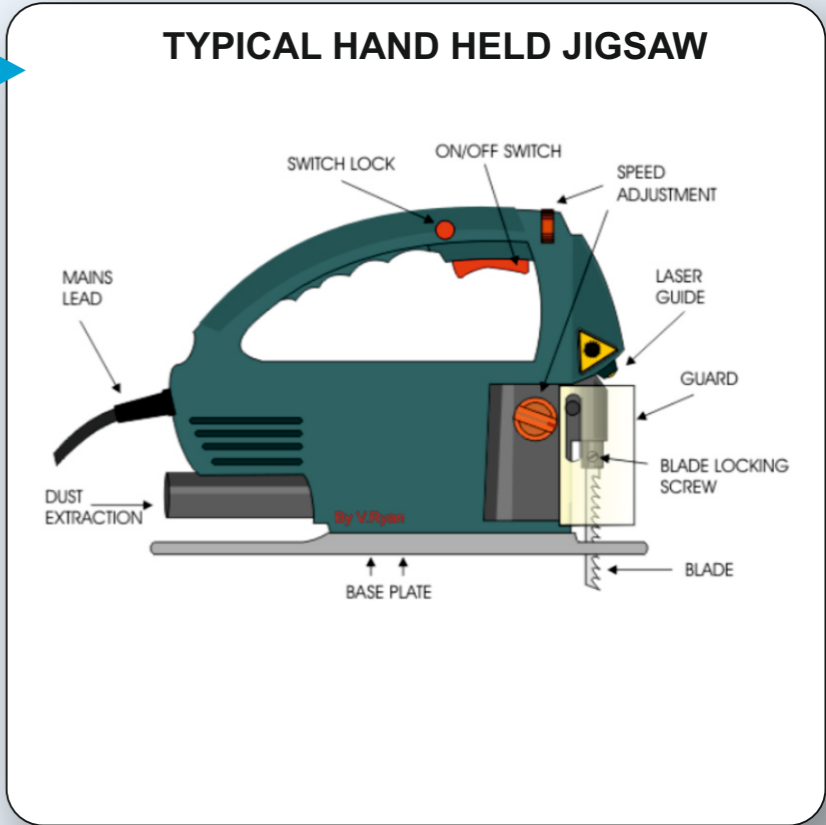

YOUR EXPLANATION - THE CIRCULAR SAW.

---

---

---

---

---

---

---

---

---

---

**3** LIST SAFETY FACTORS RELATED TO THE USE A TABLE CIRCULAR SAW.

---

---

---

---

---

---

---

---

---

---

HELPFUL LINK: <https://technologystudent.com/mobapps/saws1.pdf>

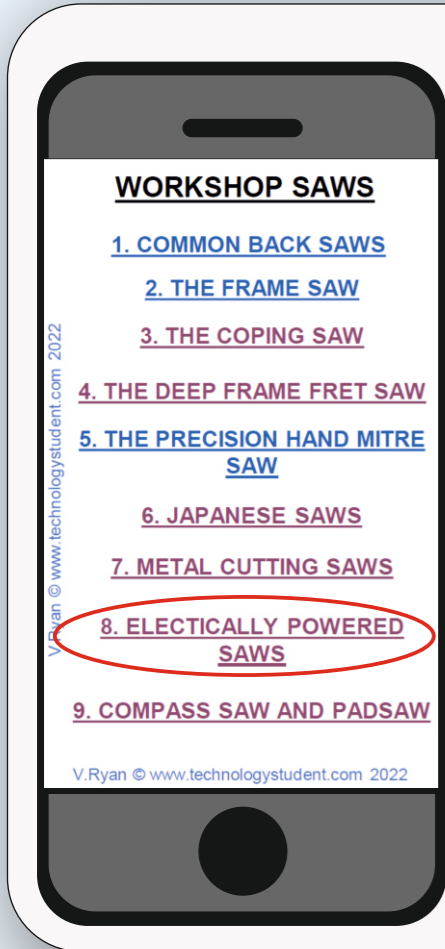

## WORKSHOP SAWS

TO ANSWER ALL THE QUESTIONS YOU WILL NEED TO DOWNLOAD THE 'SAWS - FOR ALL MATERIALS' APP, FROM THE INTERACTIVE MOBILE APP SECTION OF [www.technologystudent.com](http://www.technologystudent.com)

### LINK

<https://technologystudent.com/mobapps/saws1.pdf>

Once you have downloaded the App, you can use it to navigate the website. You may need to follow the links on each page of the App, to research / complete answers to all the questions.

**ARE YOU READY?  
USE THE MOBILE App!!**

1

DESCRIBE A POWER HACKSAW AND ITS TYPICAL USE.

---

---

---

---

---

---

---

---

---

---

TYPICAL POWER HACKSAW

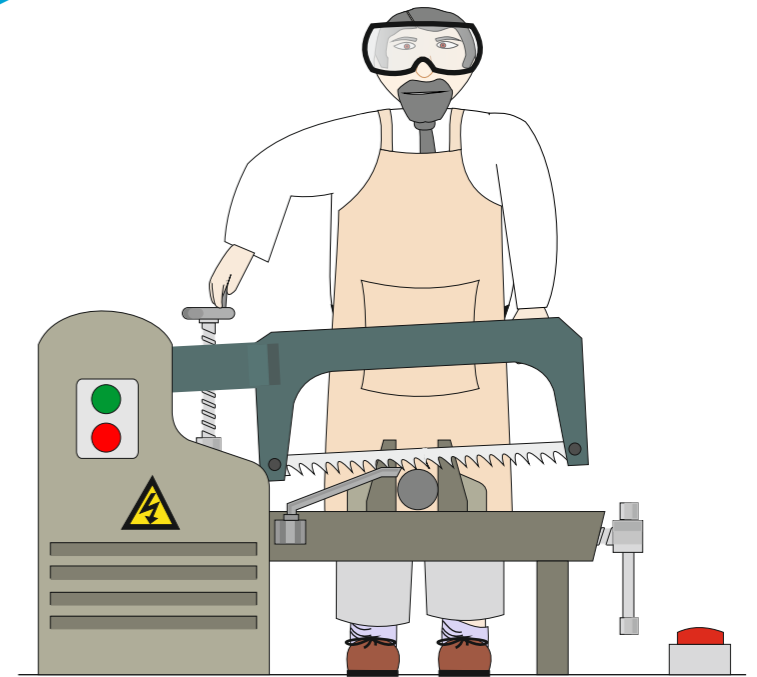

2

THE DIAGRAM BELOW, SHOWS A HAND HELD CIRCULAR SAW. IN THE BOX OPPOSITE, EXPLAIN WHEN A SAW OF THIS TYPE WOULD BE USED.

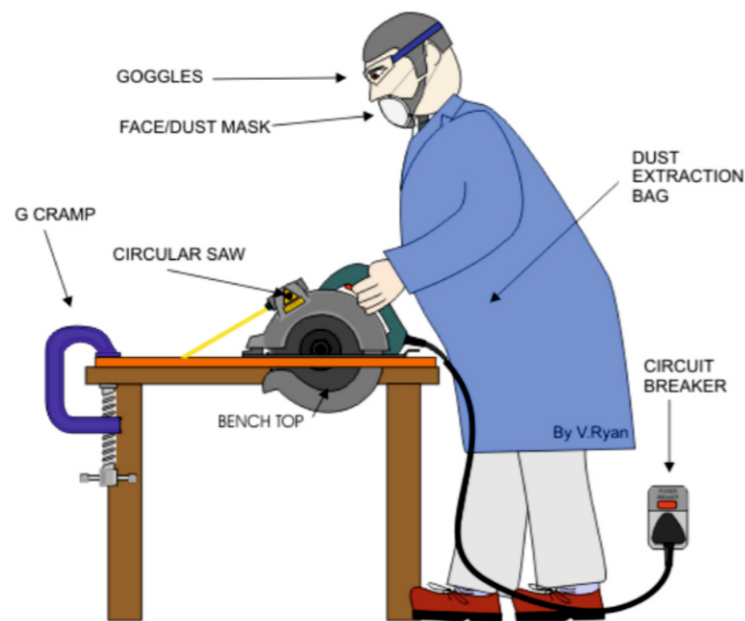

YOUR EXPLANATION

---

---

---

---

---

---

---

---

---

---

3

LIST SAFETY FACTORS RELATED TO HAND HELD CIRCULAR SAWS.

---

---

---

---

---

---

---

---

---

---

HELPFUL LINK:

<https://technologystudent.com/mobapps/saws1.pdf>

**WORKSHOP SAWS**

TO ANSWER ALL THE QUESTIONS YOU WILL NEED TO DOWNLOAD THE 'SAWS - FOR ALL MATERIALS' APP, FROM THE INTERACTIVE MOBILE APP SECTION OF [www.technologystudent.com](http://www.technologystudent.com)

**LINK**  
<https://technologystudent.com/mobapps/saws1.pdf>

Once you have downloaded the App, you can use it to navigate the website. You may need to follow the links on each page of the App, to research / complete answers to all the questions.

**ARE YOU READY?  
USE THE MOBILE App!!**



**WORKSHOP SAWS**

1. COMMON BACK SAWS
2. THE FRAME SAW
3. THE COPING SAW
4. THE DEEP FRAME FRET SAW
5. THE PRECISION HAND MITRE SAW
6. JAPANESE SAWS
7. METAL CUTTING SAWS
8. ELECTICALLY POWERED SAWS
9. COMPASS SAW AND PADSAW

**1** DESCRIBE A COMPASS SAW AND SKETCH A TYPICAL USE, IN THE BOX OPPOSITE.

---

---

---

---

---

---

---

---

---

---

**YOUR SKETCH**

**2** IN THE BOX OPPOSITE, DESCRIBE THE PADSAW AND ITS TYPICAL USE.

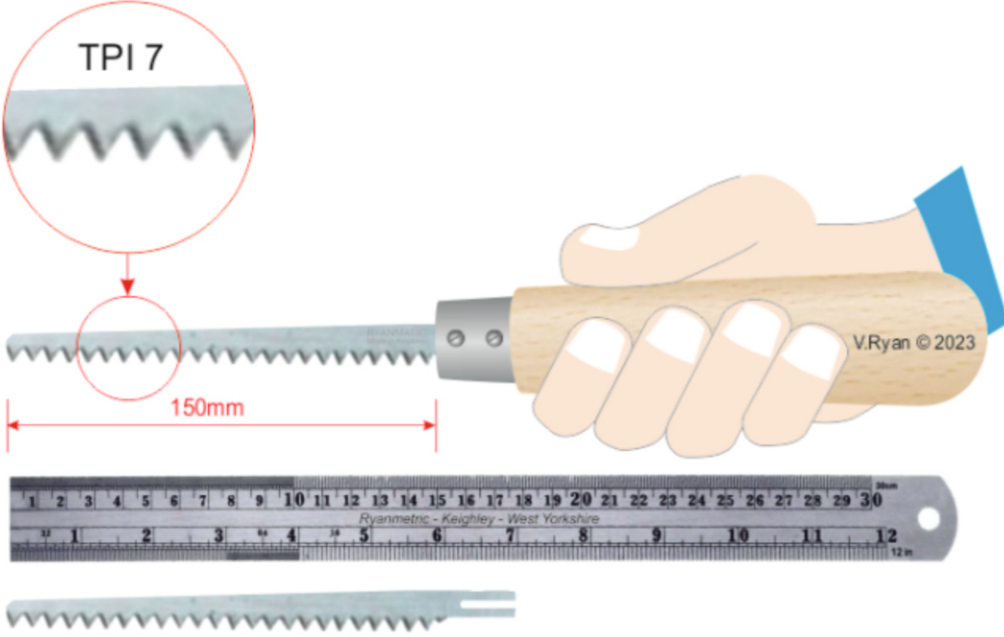

**YOUR DESCRIPTION**

---

---

---

---

---

---

---

---

---

---

**3** HOW DOES A COMPASS SAW DIFFER FROM A PADSAW?

---

---

---

---

---

---

---

---

---

---

**HELPFUL LINK:** <https://technologystudent.com/mobapps/saws1.pdf>