

ISOMETRIC CUBES AND SHADING TECHNIQUES

By V.Ryan

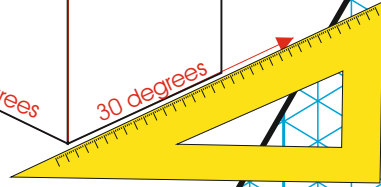

THREE TONE SHADING

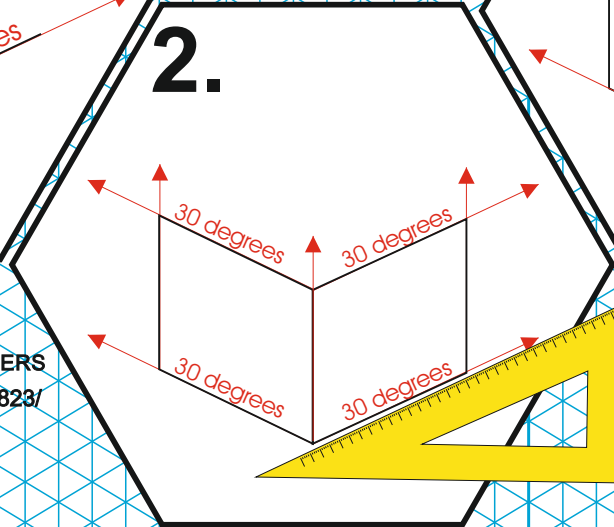
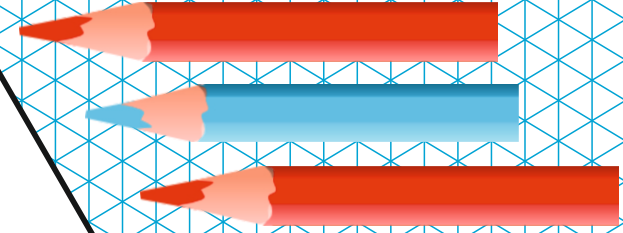
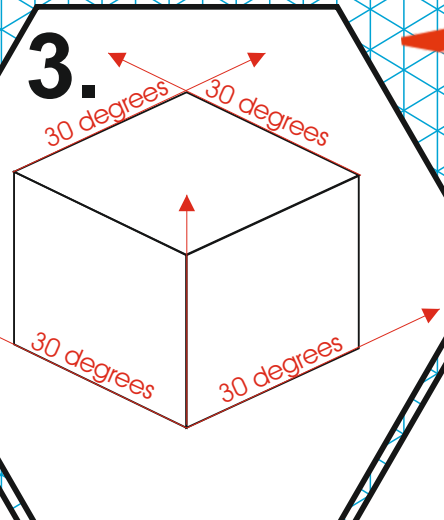
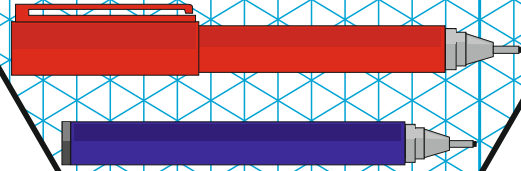
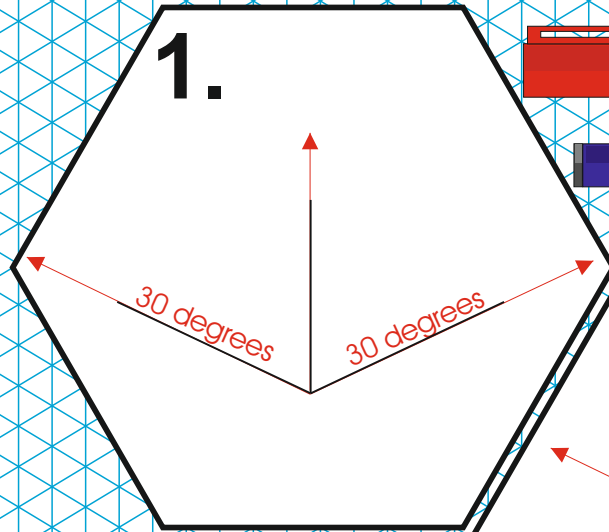
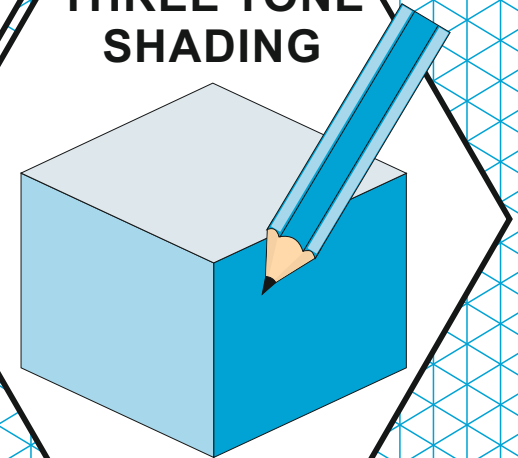

WORLD ASSOCIATION OF TECHNOLOGY TEACHERS
<https://www.facebook.com/groups/254963448192823/>
www.technologystudent.com © 2017

QUICK PENCIL SHADING

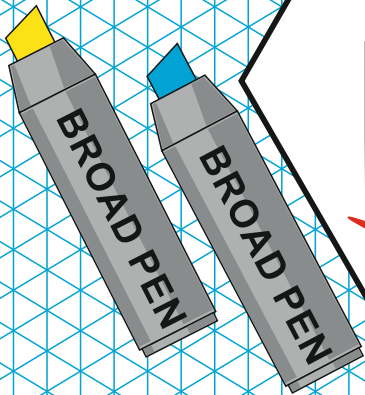
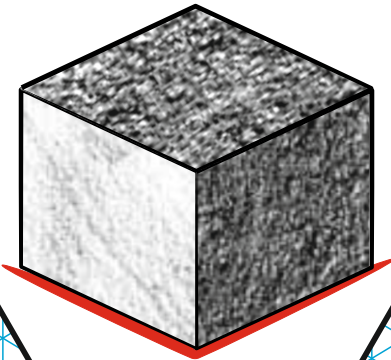

RADIAL SHADING

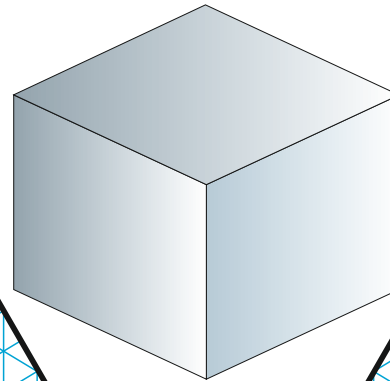

LINE SHADING

