

POWER TOOLS

WORLD ASSOCIATION OF TECHNOLOGY TEACHERS <https://www.facebook.com/groups/254963448192823/> www.technologystudent.com © 2023 V.Ryan © 2023

TO ANSWER ALL THE QUESTIONS YOU WILL NEED TO
DOWNLOAD THE “POWER TOOLS” APP, FROM THE
INTERACTIVE MOBILE APP SECTION OF
www.technologystudent.com

**CLICK ON THE
BUTTON
TO DOWNLOAD
THE APP**

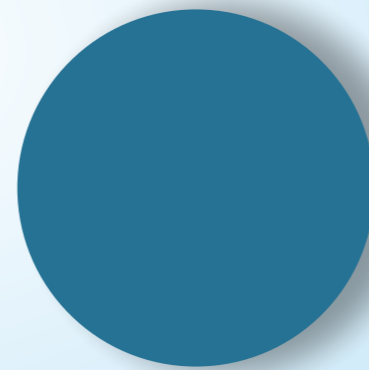

Once you have downloaded the App, you can use it to navigate the website. You may need to follow the links on each page of the App, to research / complete answers to all the questions.

IF YOU ARE AN EDUCATOR, CONSIDER JOINING US AT FACEBOOK – WORLD ASSOCIATION OF TECHNOLOGY TEACHERS

<https://www.facebook.com/groups/254963448192823/>

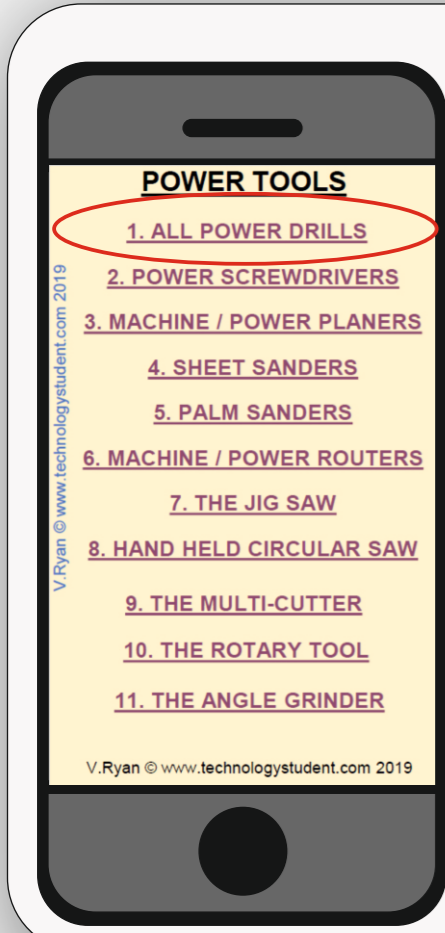

POWER DRILLS

TO ANSWER ALL THE QUESTIONS YOU WILL NEED TO DOWNLOAD THE 'POWER TOOLS' APP, FROM THE INTERACTIVE MOBILE APP SECTION OF www.technologystudent.com

LINK

<https://www.technologystudent.com/mobapps/powertools1.pdf>

Once you have downloaded the App, you can use it to navigate the website. You may need to follow the links on each page of the App, to research / complete answers to all the questions.

**ARE YOU READY?
USE THE MOBILE App!!**

1

WRITE THREE SAFETY FACTORS THAT APPLY WHEN USING A CORDED POWERED DRILL.
(Typical power drill shown opposite)

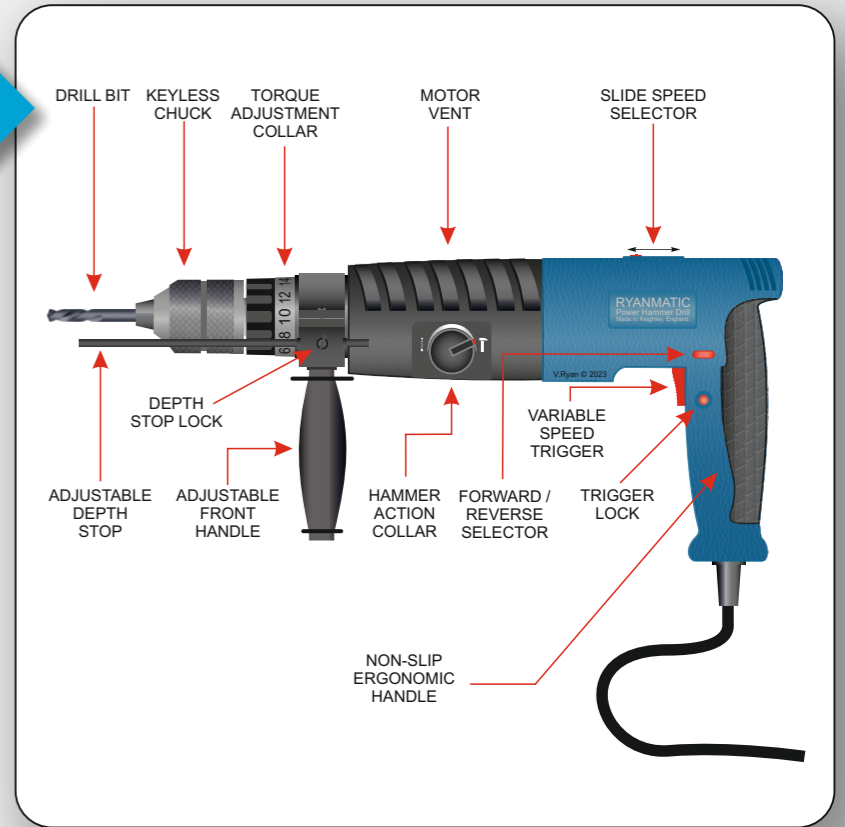

2

WHAT IS THE 'HAMMER' SETTING OF THE POWER DRILL?

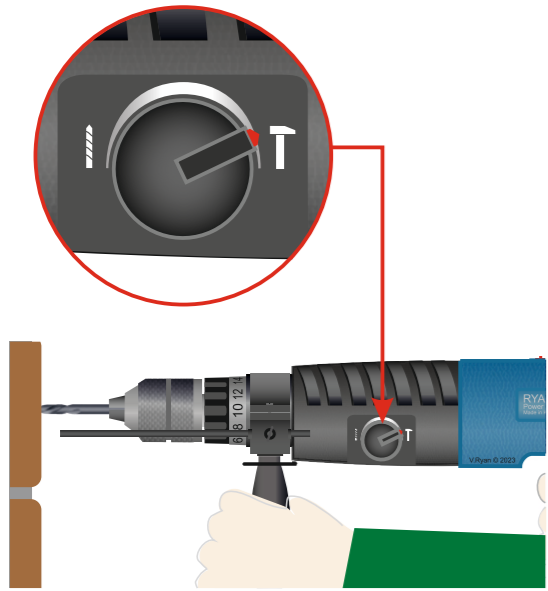

3

HOW USEFUL IS A DRILL STAND, WHEN USING A POWER DRILL?

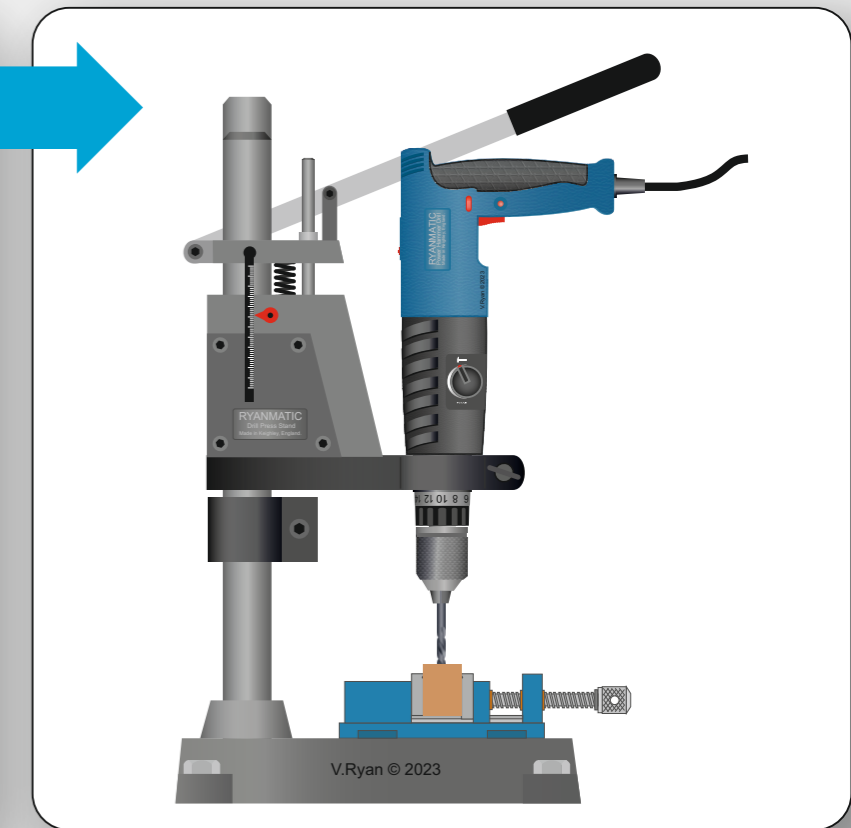

HELPFUL LINK: <https://www.technologystudent.com/mobapps/powertools1.pdf>

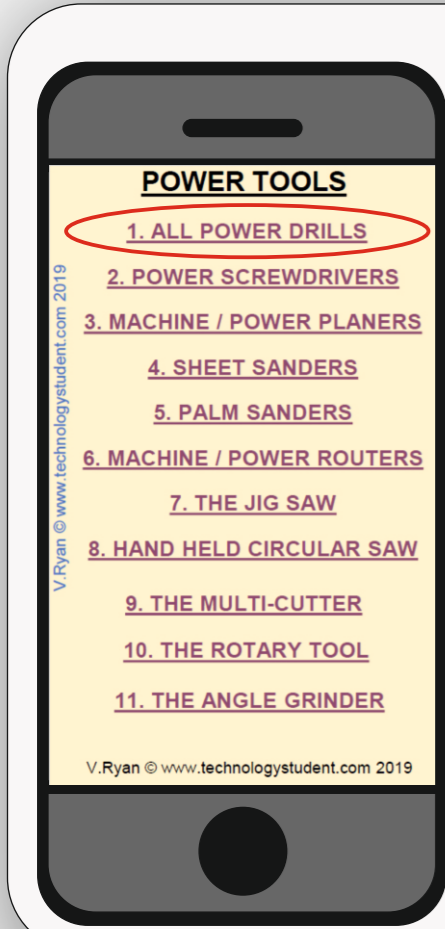

POWER DRILLS

TO ANSWER ALL THE QUESTIONS YOU WILL NEED TO DOWNLOAD THE 'POWER TOOLS' APP, FROM THE INTERACTIVE MOBILE APP SECTION OF www.technologystudent.com

LINK

<https://www.technologystudent.com/mobapps/powertools1.pdf>

Once you have downloaded the App, you can use it to navigate the website. You may need to follow the links on each page of the App, to research / complete answers to all the questions.

**ARE YOU READY?
USE THE MOBILE App!!**

1

LIST SOME ADVANTAGES OF A CORDLESS POWER DRILL OVER A CORDED DRILL. (Typical cordless drill shown opposite)



2

WHAT IS AN SDS POWER DRILL? HOW DOES IT DIFFER FROM OTHER POWER DRILLS

3

IN THE SPACE BELOW, PASTE A LABELLED IMAGE OF AN SDS DRILL

HELPFUL LINK: <https://www.technologystudent.com/mobapps/powertools1.pdf>

DRILL BITS

TO ANSWER ALL THE QUESTIONS YOU WILL NEED TO DOWNLOAD THE 'POWER TOOLS' APP, FROM THE INTERACTIVE MOBILE APP SECTION OF www.technologystudent.com

LINK

<https://www.technologystudent.com/mobapps/powertools1.pdf>

Once you have downloaded the App, you can use it to navigate the website. You may need to follow the links on each page of the App, to research / complete answers to all the questions.

**ARE YOU READY?
USE THE MOBILE App!!**

- POWER TOOLS**
- 1. ALL POWER DRILLS
 - 2. POWER SCREWDRIVERS
 - 3. MACHINE / POWER PLANERS
 - 4. SHEET SANDERS
 - 5. PALM SANDERS
 - 6. MACHINE / POWER ROUTERS
 - 7. THE JIG SAW
 - 8. HAND HELD CIRCULAR SAW
 - 9. THE MULTI-CUTTER
 - 10. THE ROTARY TOOL
 - 11. THE ANGLE GRINDER

V.Ryan © www.technologystudent.com 2019

V.Ryan © www.technologystudent.com 2019

1

NAME AND DESCRIBE THE PURPOSE OF THE TWO DRILL BITS SHOWN OPPOSITE.

A:

B:



A



B



2

NAME TWO OF THE DRILL BITS SHOWN OPPOSITE. DESCRIBE THE GENERAL USE OF THE DRILL BITS YOU HAVE SELECTED.



NAME:



NAME:



NAME:



HELPFUL LINK: <https://www.technologystudent.com/mobapps/powertools1.pdf>

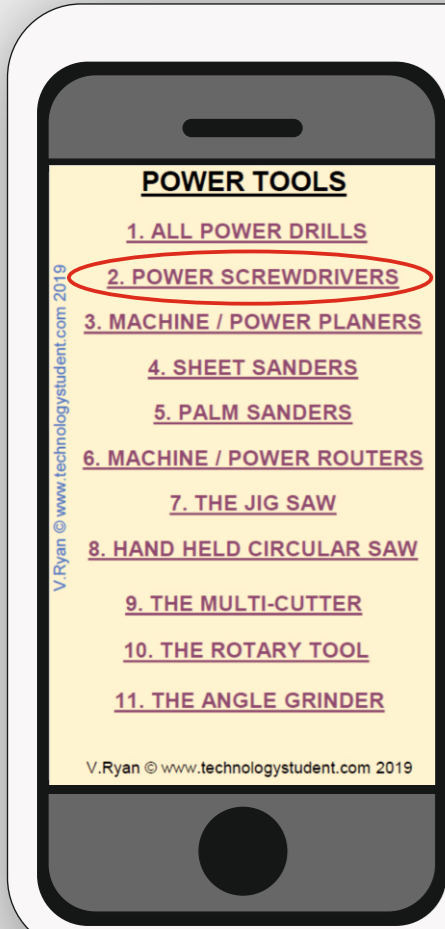

POWER SCREWDRIVER

TO ANSWER ALL THE QUESTIONS YOU WILL NEED TO DOWNLOAD THE 'POWER TOOLS' APP, FROM THE INTERACTIVE MOBILE APP SECTION OF www.technologystudent.com

LINK

<https://www.technologystudent.com/mobapps/powertools1.pdf>

Once you have downloaded the App, you can use it to navigate the website. You may need to follow the links on each page of the App, to research / complete answers to all the questions.

**ARE YOU READY?
USE THE MOBILE App!!**

1

WHAT IS A POWER SCREWDRIVER?
(As shown opposite)



2

LIST SAFETY FACTORS WHEN USING A POWER SCREWDRIVER.

3

COMPLETE THE DIAGRAM OF A POWER SCREWDRIVER BY ADDING THE MISSING LABELS



HELPFUL LINK: <https://www.technologystudent.com/mobapps/powertools1.pdf>

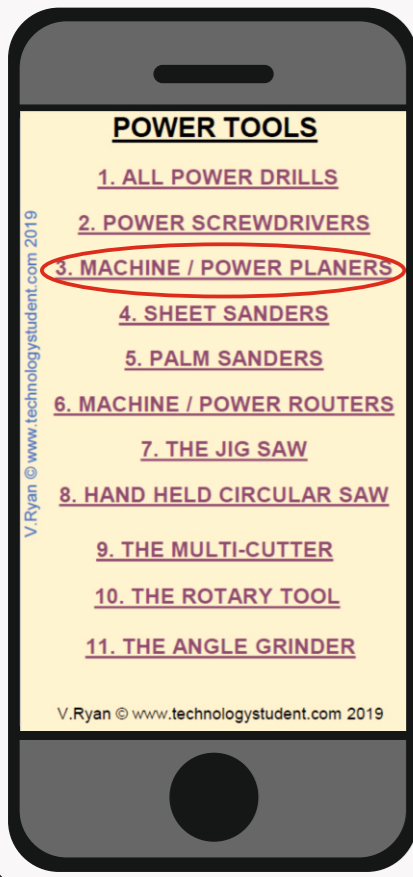

POWER PLANERS

TO ANSWER ALL THE QUESTIONS YOU WILL NEED TO DOWNLOAD THE 'POWER TOOLS' APP, FROM THE INTERACTIVE MOBILE APP SECTION OF www.technologystudent.com

LINK

<https://www.technologystudent.com/mobapps/powertools1.pdf>

Once you have downloaded the App, you can use it to navigate the website. You may need to follow the links on each page of the App, to research / complete answers to all the questions.

**ARE YOU READY?
USE THE MOBILE App!!**

1 WHEN IS A POWER PLANER USED IN PLACE OF A NORMAL HAND PLANE?
(Typical power planer shown opposite)

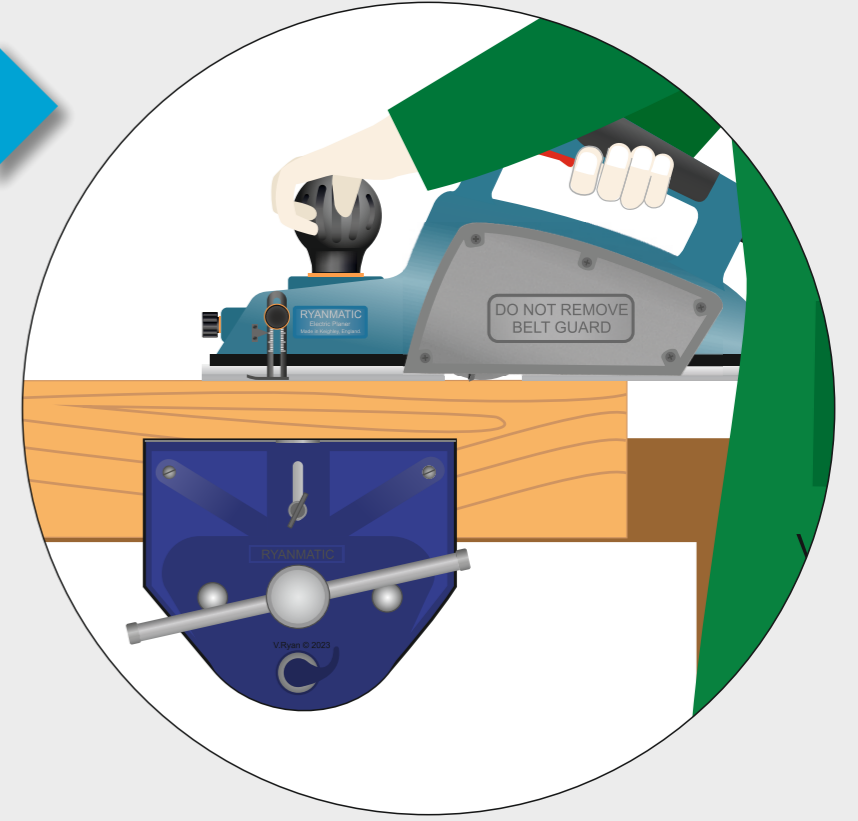
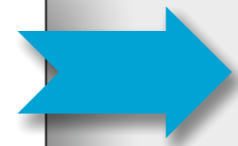

2 LIST SAFETY FACTORS WHEN USING A POWER PLANE.

3 COMPLETE THE DIAGRAM OF A POWER PLANER BY ADDING THE MISSING LABELS

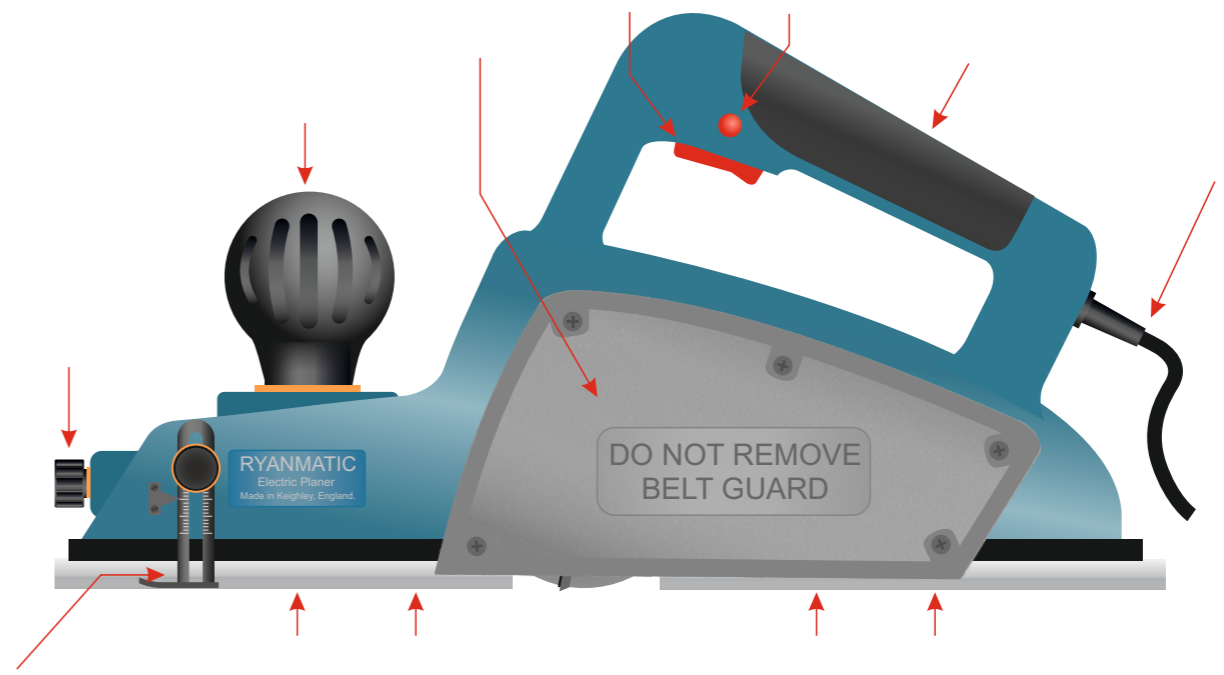

HELPFUL LINK: <https://www.technologystudent.com/mobapps/powertools1.pdf>

SHEET SANDERS

TO ANSWER ALL THE QUESTIONS YOU WILL NEED TO DOWNLOAD THE 'POWER TOOLS' APP, FROM THE INTERACTIVE MOBILE APP SECTION OF www.technologystudent.com

LINK

<https://www.technologystudent.com/mobapps/powertools1.pdf>

Once you have downloaded the App, you can use it to navigate the website. You may need to follow the links on each page of the App, to research / complete answers to all the questions.

**ARE YOU READY?
USE THE MOBILE App!!**

1

WHEN IS A SHEET SANDER USED INSTEAD OF SANDING A SURFACE BY HAND?
(Sheet sander shown opposite)



2

HOW IS THE SHEET OF GLASS PAPER REPLACED WHEN IT IS WORN OUT?

3

COMPLETE THE DIAGRAM OF A SHEET SANDER BY ADDING THE MISSING LABELS

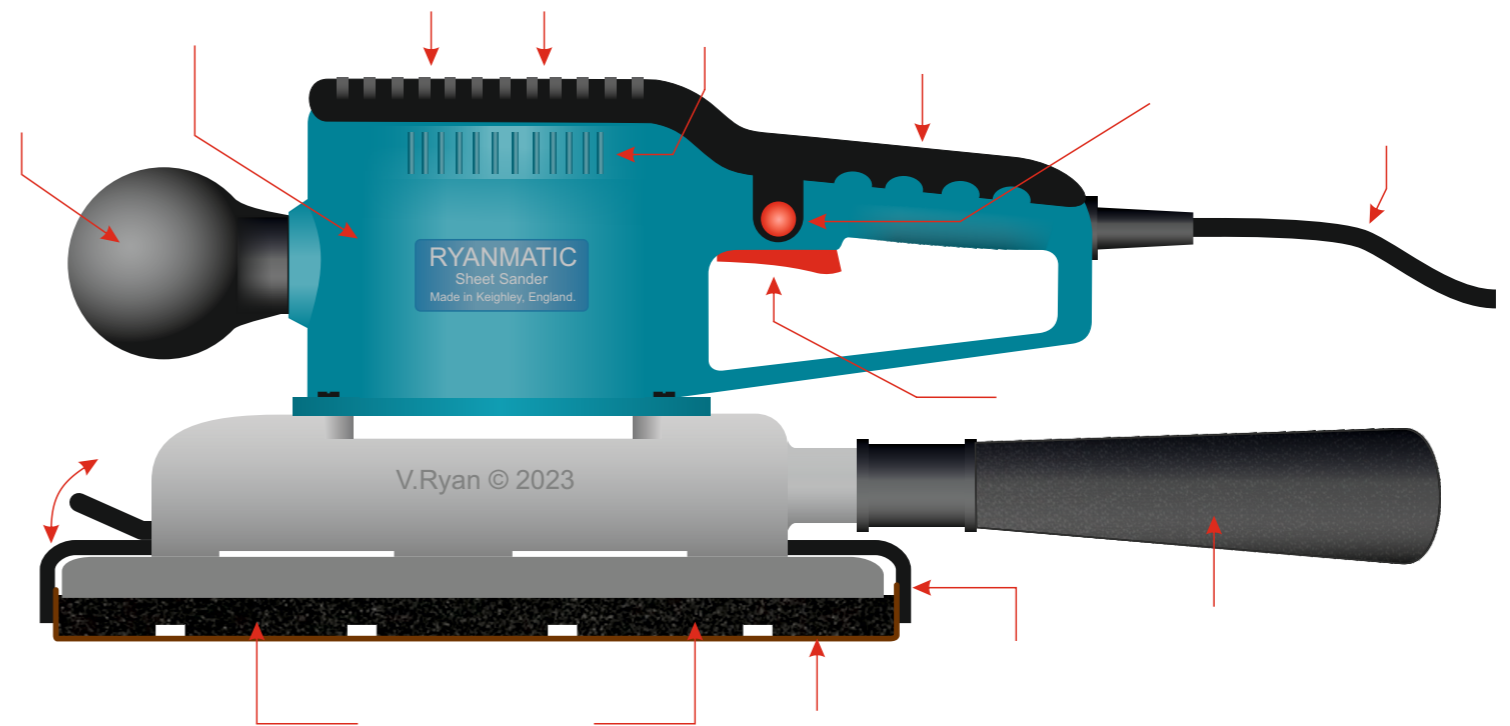

HELPFUL LINK: <https://www.technologystudent.com/mobapps/powertools1.pdf>

PALM SANDERS

TO ANSWER ALL THE QUESTIONS YOU WILL NEED TO DOWNLOAD THE 'POWER TOOLS' APP, FROM THE INTERACTIVE MOBILE APP SECTION OF www.technologystudent.com

LINK

<https://www.technologystudent.com/mobapps/powertools1.pdf>

Once you have downloaded the App, you can use it to navigate the website. You may need to follow the links on each page of the App, to research / complete answers to all the questions.

**ARE YOU READY?
USE THE MOBILE App!!**

1

DESCRIBE SOME OF THE FEATURES OF A PALM SANDER.



PALM SANDER



2

DESCRIBE THE 'SAFE' USE OF A PALM SANDER

3

COMPLETE THE DIAGRAM OF A PALM SANDER BY ADDING THE MISSING LABELS

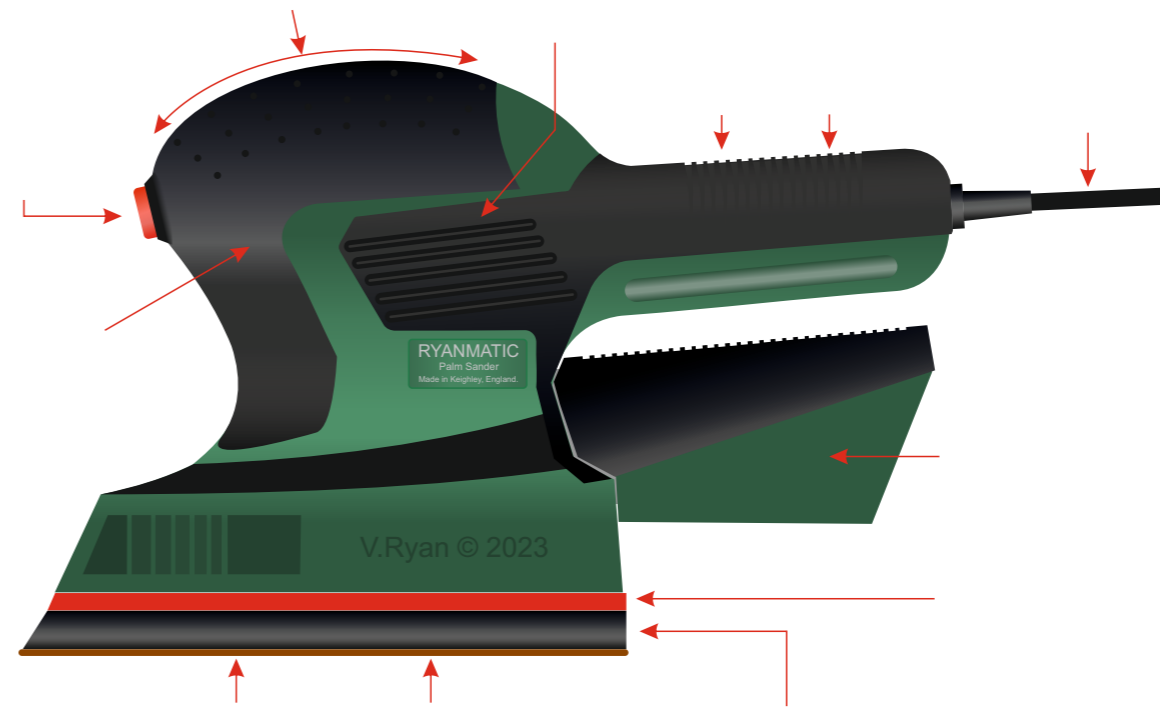

HELPFUL LINK: <https://www.technologystudent.com/mobapps/powertools1.pdf>

POWER ROUTERS

TO ANSWER ALL THE QUESTIONS YOU WILL NEED TO DOWNLOAD THE 'POWER TOOLS' APP, FROM THE INTERACTIVE MOBILE APP SECTION OF www.technologystudent.com

LINK

<https://www.technologystudent.com/mobapps/powertools1.pdf>

Once you have downloaded the App, you can use it to navigate the website. You may need to follow the links on each page of the App, to research / complete answers to all the questions.

**ARE YOU READY?
USE THE MOBILE App!!**

- POWER TOOLS**
1. ALL POWER DRILLS
 2. POWER SCREWDRIVERS
 3. MACHINE / POWER PLANERS
 4. SHEET SANDERS
 5. PALM SANDERS
 6. MACHINE / POWER ROUTERS
 7. THE JIG SAW
 8. HAND HELD CIRCULAR SAW
 9. THE MULTI-CUTTER
 10. THE ROTARY TOOL
 11. THE ANGLE GRINDER

1

WHAT ARE POWER ROUTERS USED FOR?



POWER ROUTER

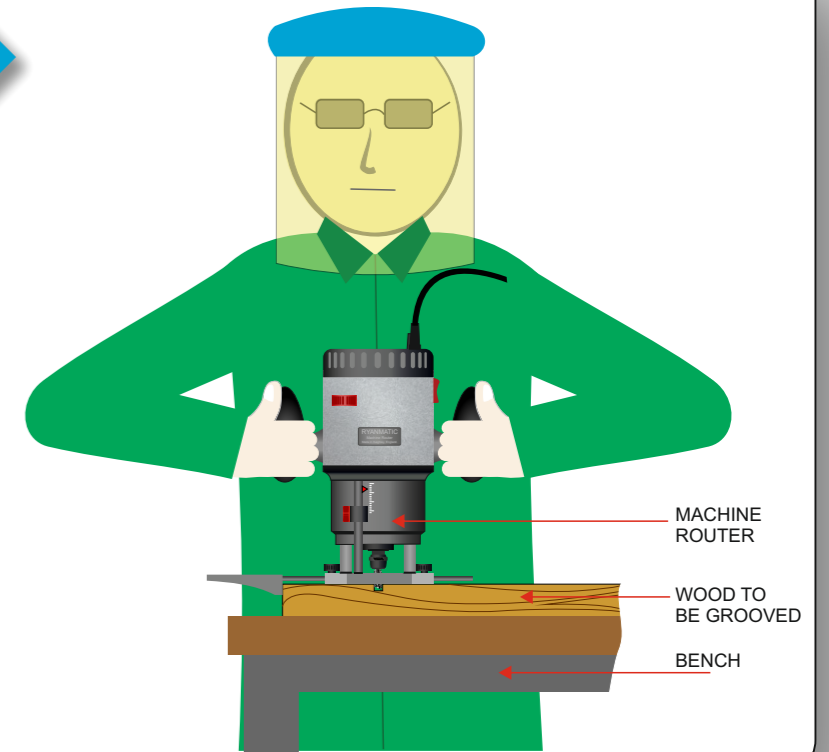

2

DESCRIBE THE 'SAFE' USE OF A POWER ROUTER

3

COMPLETE THE DIAGRAM OF A POWER ROUTER BY ADDING THE MISSING LABELS:

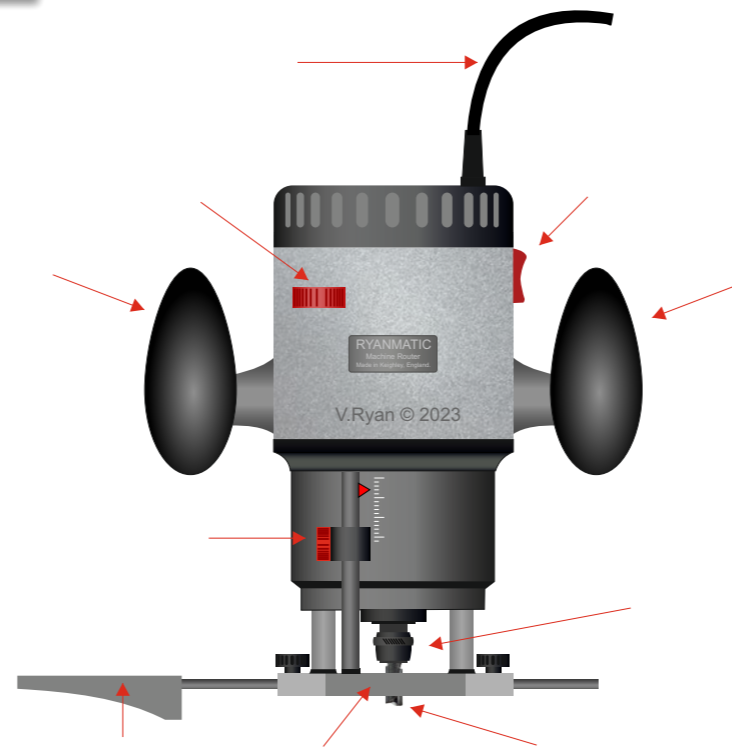

NAME THE ROUTER BITS SHOWN BELOW



HELPFUL LINK: <https://www.technologystudent.com/mobapps/powertools1.pdf>

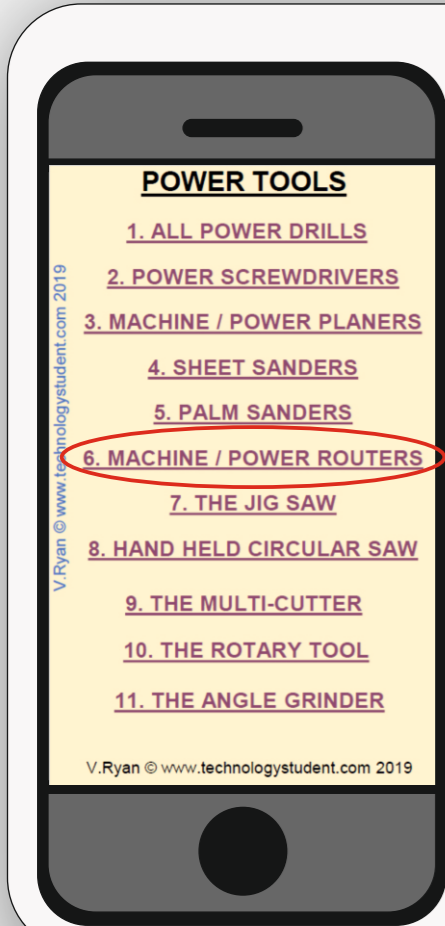
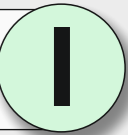

INVERTED ROUTER TABLE

TO ANSWER ALL THE QUESTIONS YOU WILL NEED TO DOWNLOAD THE 'POWER TOOLS' APP, FROM THE INTERACTIVE MOBILE APP SECTION OF www.technologystudent.com

LINK

<https://www.technologystudent.com/mobapps/powertools1.pdf>

Once you have downloaded the App, you can use it to navigate the website. You may need to follow the links on each page of the App, to research / complete answers to all the questions.

**ARE YOU READY?
USE THE MOBILE App!!**

1

WHAT IS AN INVERTED ROUTER TABLE?



INVERTED ROUTER TABLE

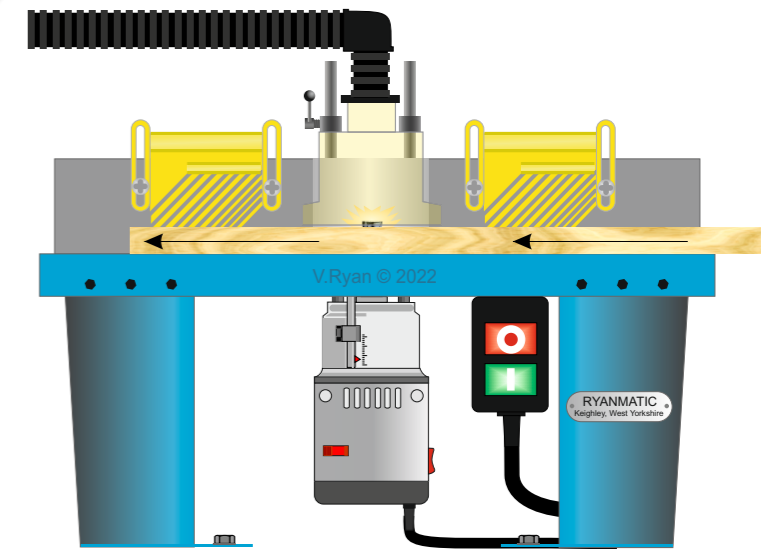

2

DESCRIBE THE 'SAFE' USE OF A INVERTED ROUTER TABLE, AS SHOWN OPPOSITE

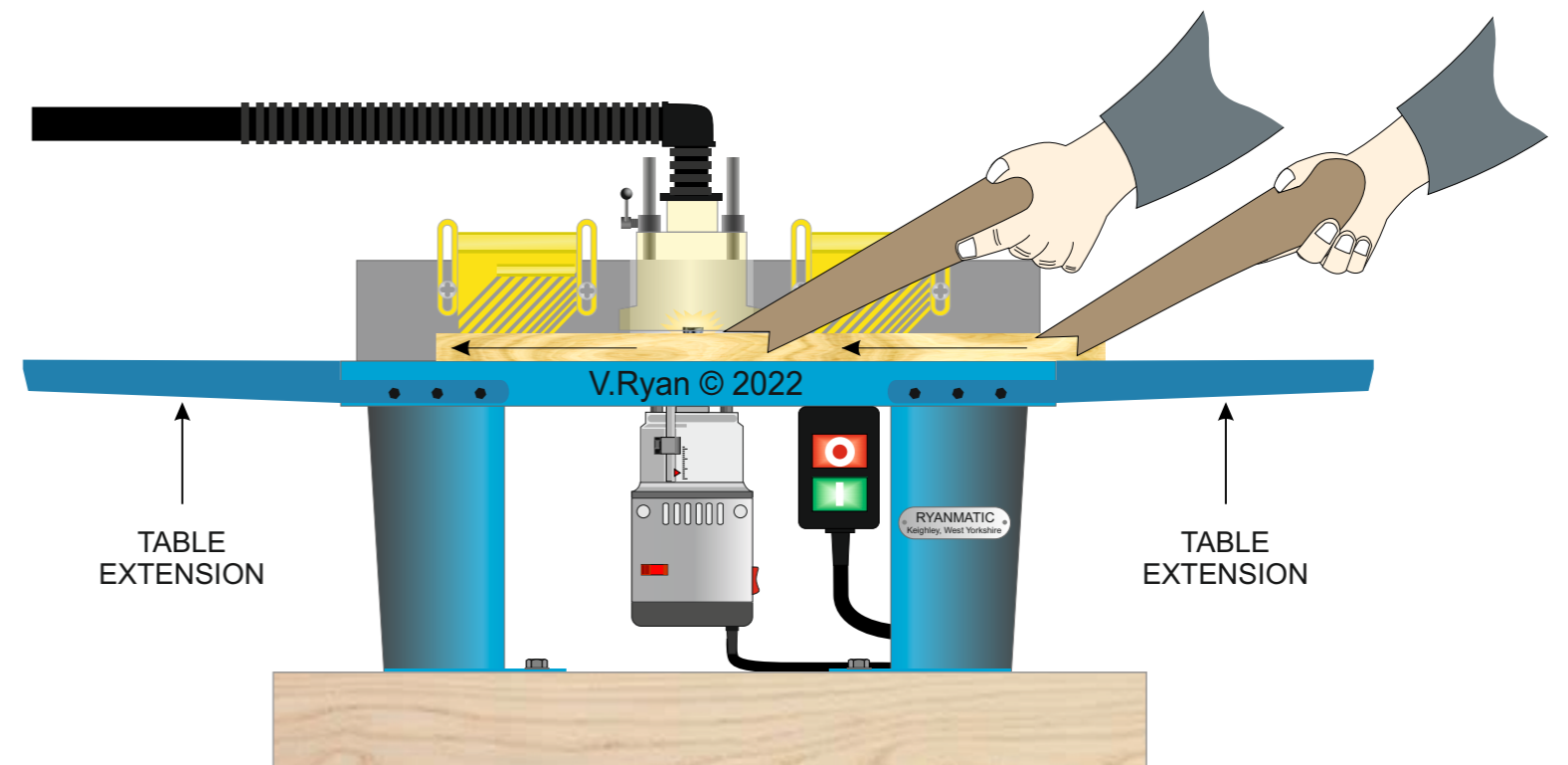

HELPFUL LINK: <https://www.technologystudent.com/mobapps/powertools1.pdf>

THE JIG SAW

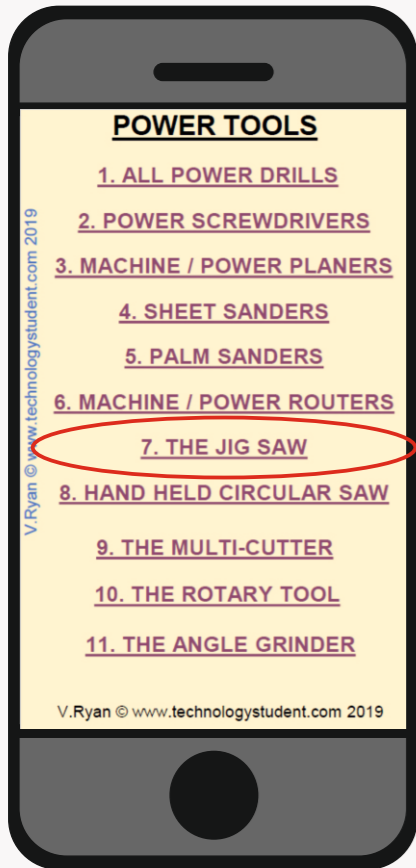

TO ANSWER ALL THE QUESTIONS YOU WILL NEED TO DOWNLOAD THE 'POWER TOOLS' APP, FROM THE INTERACTIVE MOBILE APP SECTION OF www.technologystudent.com

LINK

<https://www.technologystudent.com/mobapps/powertools1.pdf>

Once you have downloaded the App, you can use it to navigate the website. You may need to follow the links on each page of the App, to research / complete answers to all the questions.

**ARE YOU READY?
USE THE MOBILE App!!**

1

DESCRIBE THE GENERAL FUNCTIONS OF A JIG SAW? (What is it used for?)



JIG SAW IN USE



2

DESCRIBE THE 'SAFE' USE OF A JIG SAW.

3

COMPLETE THE DIAGRAM OF A JIG SAW, BY ADDING THE MISSING LABELS.

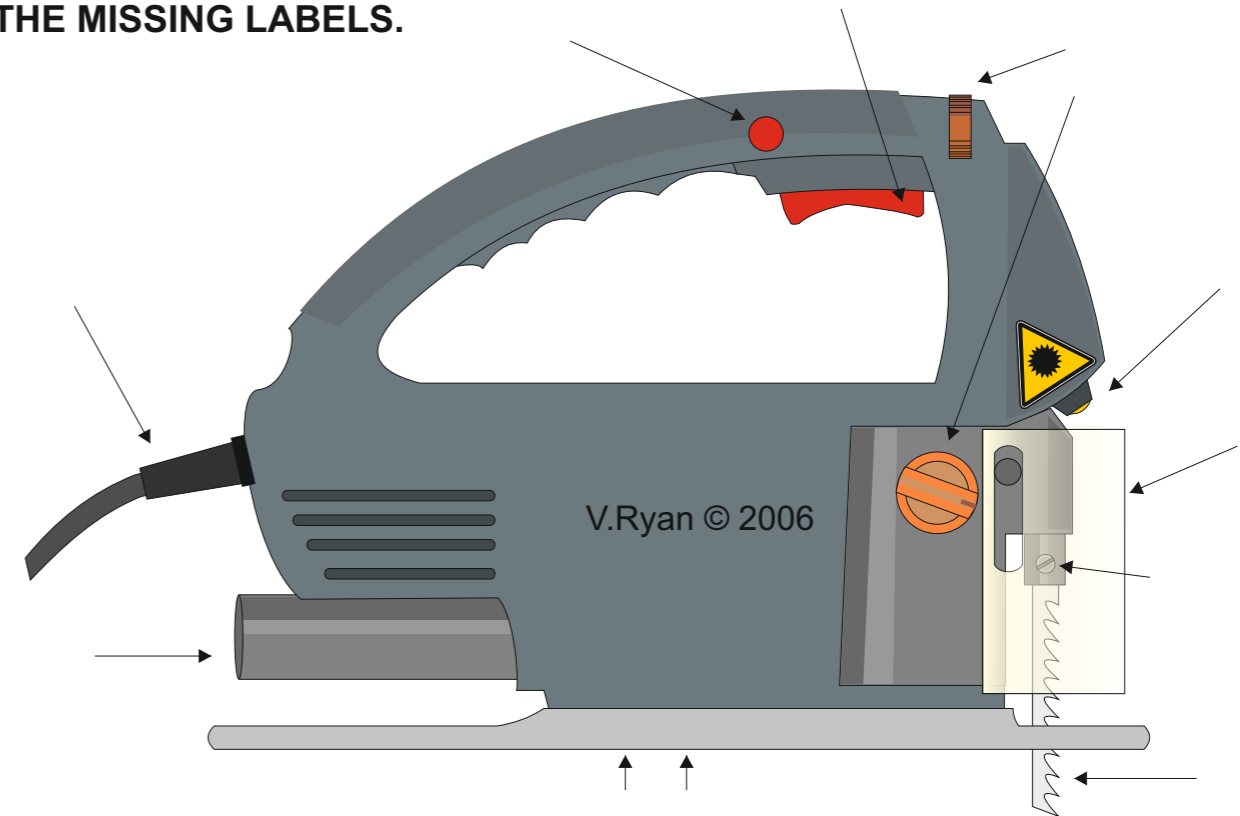

HELPFUL LINK: <https://www.technologystudent.com/mobapps/powertools1.pdf>

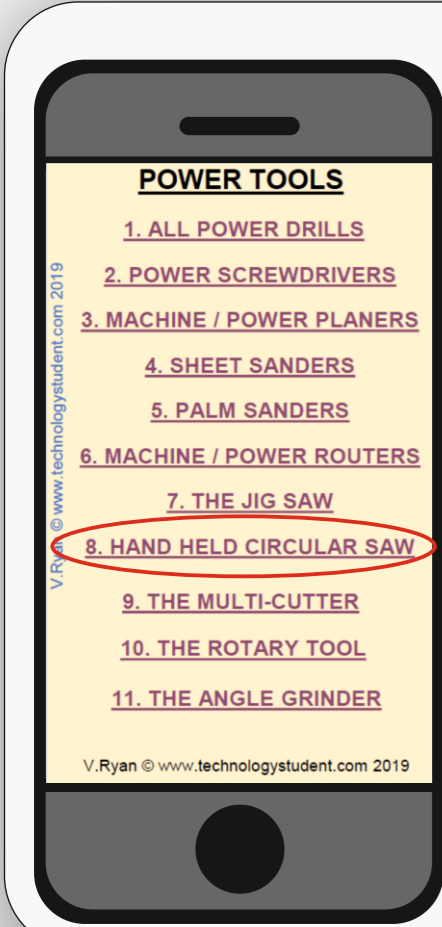

HAND HELD CIRCULAR SAW

TO ANSWER ALL THE QUESTIONS YOU WILL NEED TO DOWNLOAD THE 'POWER TOOLS' APP, FROM THE INTERACTIVE MOBILE APP SECTION OF www.technologystudent.com

LINK

<https://www.technologystudent.com/mobapps/powertools1.pdf>

Once you have downloaded the App, you can use it to navigate the website. You may need to follow the links on each page of the App, to research / complete answers to all the questions.

**ARE YOU READY?
USE THE MOBILE App!!**

1

DESCRIBE THE GENERAL FUNCTIONS OF A HAND HELD CIRCULAR SAW.
(What is it used for?)



HAND HELD CIRCULAR SAW

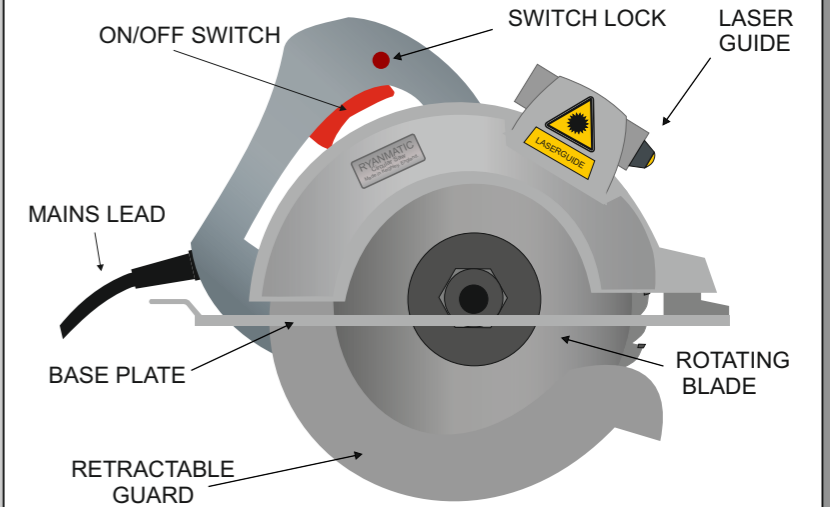

2

EXPLAIN THE PURPOSE OF THE LASER GUIDE

3

DESCRIBE THE 'SAFE' USE OF A HAND HELD CIRCULAR SAW.

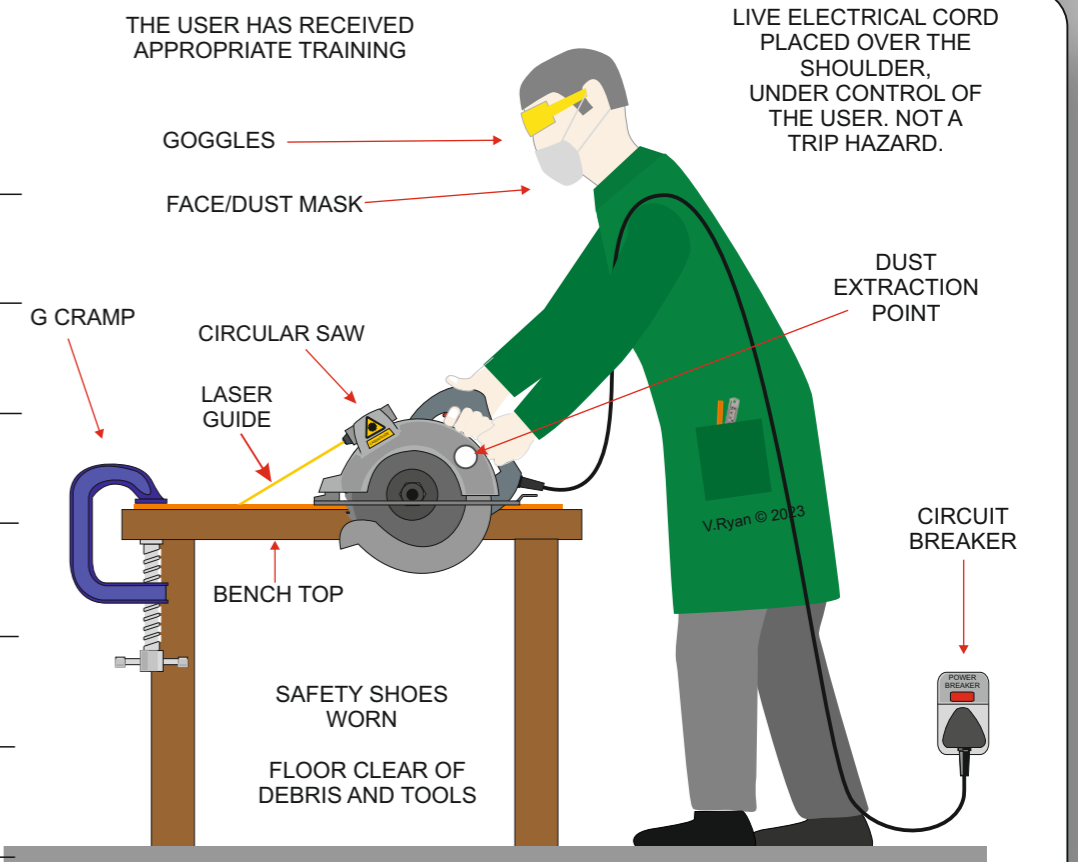

HELPFUL LINK: <https://www.technologystudent.com/mobapps/powertools1.pdf>

THE MULTI-CUTTER



TO ANSWER ALL THE QUESTIONS YOU WILL NEED TO DOWNLOAD THE 'POWER TOOLS' APP, FROM THE INTERACTIVE MOBILE APP SECTION OF www.technologystudent.com

LINK

<https://www.technologystudent.com/mobapps/powertools1.pdf>

Once you have downloaded the App, you can use it to navigate the website. You may need to follow the links on each page of the App, to research / complete answers to all the questions.

**ARE YOU READY?
USE THE MOBILE App!!**

1

DESCRIBE THE GENERAL FUNCTIONS OF A MULTI-CUTTER (What is it used for?)



TYPICAL MULTI-CUTTER

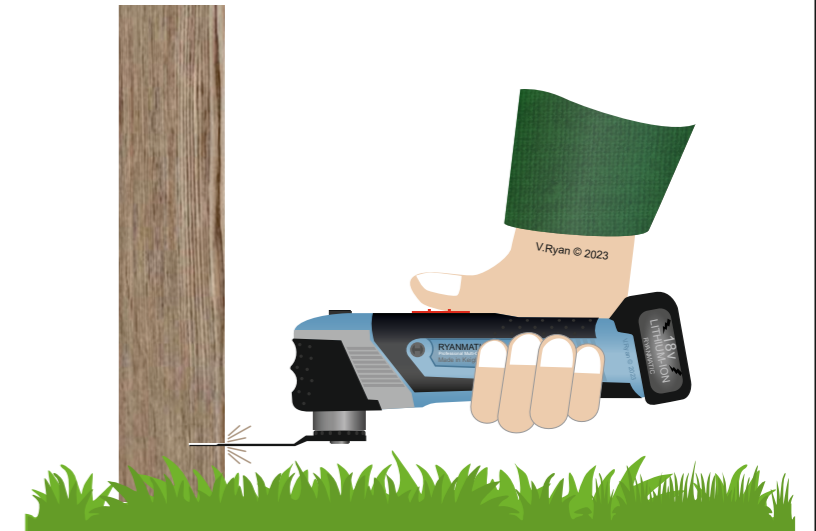

2

WHAT ARE THE ADVANTAGES OF USING A CORDLESS / BATTERY POWERED VERSION OF THE MULTI-CUTTER?

3

COMPLETE THE DIAGRAM OF A MULTI-CUTTER BY ADDING THE MISSING LABELS.

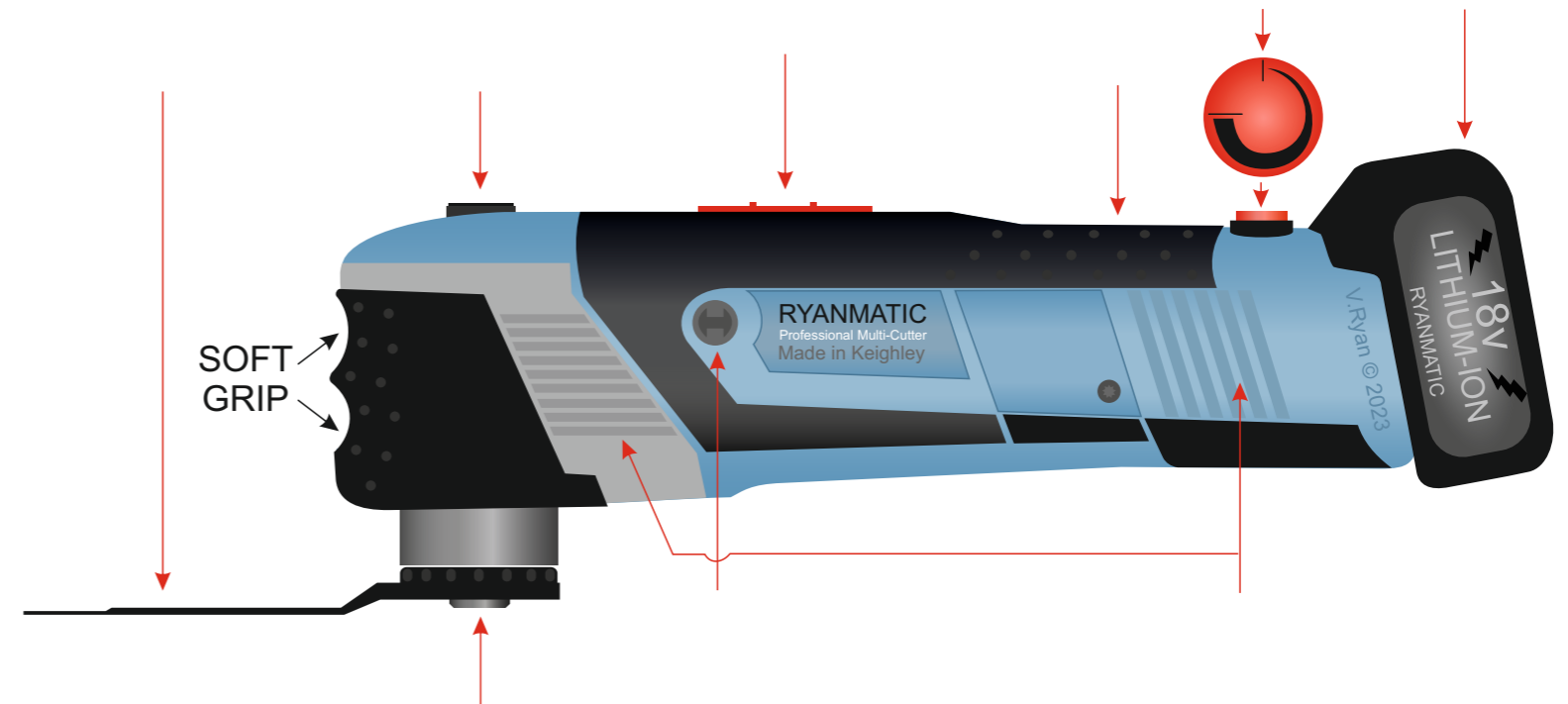

HELPFUL LINK: <https://www.technologystudent.com/mobapps/powertools1.pdf>

THE ROTARY TOOL



TO ANSWER ALL THE QUESTIONS YOU WILL NEED TO DOWNLOAD THE 'POWER TOOLS' APP, FROM THE INTERACTIVE MOBILE APP SECTION OF www.technologystudent.com

LINK

<https://www.technologystudent.com/mobapps/powertools1.pdf>

Once you have downloaded the App, you can use it to navigate the website. You may need to follow the links on each page of the App, to research / complete answers to all the questions.

**ARE YOU READY?
USE THE MOBILE App!!**

1

DESCRIBE THE GENERAL FUNCTIONS OF A ROTARY TOOL (What is it used for?)



TYPICAL ROTARY TOOL

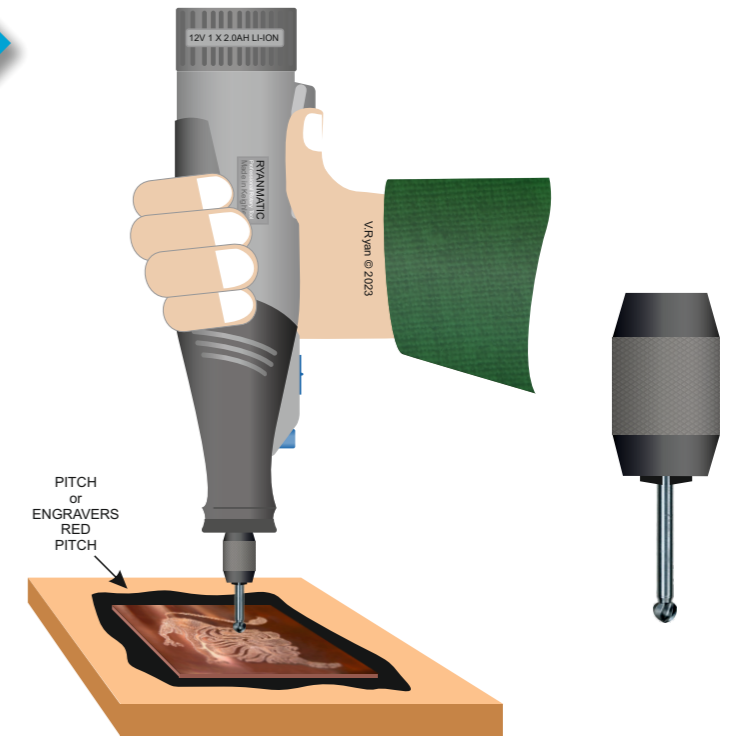

2

THIS CUTTER IS FOR ENGRAVING. WHAT IS ENGRAVING?



3

IN THE SPACE BELOW, PASTE AN IMAGE(S) OF A VARIETY OF CUTTERS, THAT CAN BE USED WITH THE ROTARY CUTTER.

HELPFUL LINK: <https://www.technologystudent.com/mobapps/powertools1.pdf>

THE ANGLE GRINDER

TO ANSWER ALL THE QUESTIONS YOU WILL NEED TO DOWNLOAD THE 'POWER TOOLS' APP, FROM THE INTERACTIVE MOBILE APP SECTION OF www.technologystudent.com

LINK

<https://www.technologystudent.com/mobapps/powertools1.pdf>

Once you have downloaded the App, you can use it to navigate the website. You may need to follow the links on each page of the App, to research / complete answers to all the questions.

**ARE YOU READY?
USE THE MOBILE App!!**

1

DESCRIBE THE GENERAL FUNCTIONS OF AN ANGLE GRINDER
(What is it used for?)

TYPICAL ANGLE GRINDER



2

DESCRIBE THE 'SAFE' USE OF AN ANGLE GRINDER FOR CUTTING / GRINDING.

3

COMPLETE THE DIAGRAM OF THE ANGLE GRINDER, BY ADDING THE MISSING LABELS

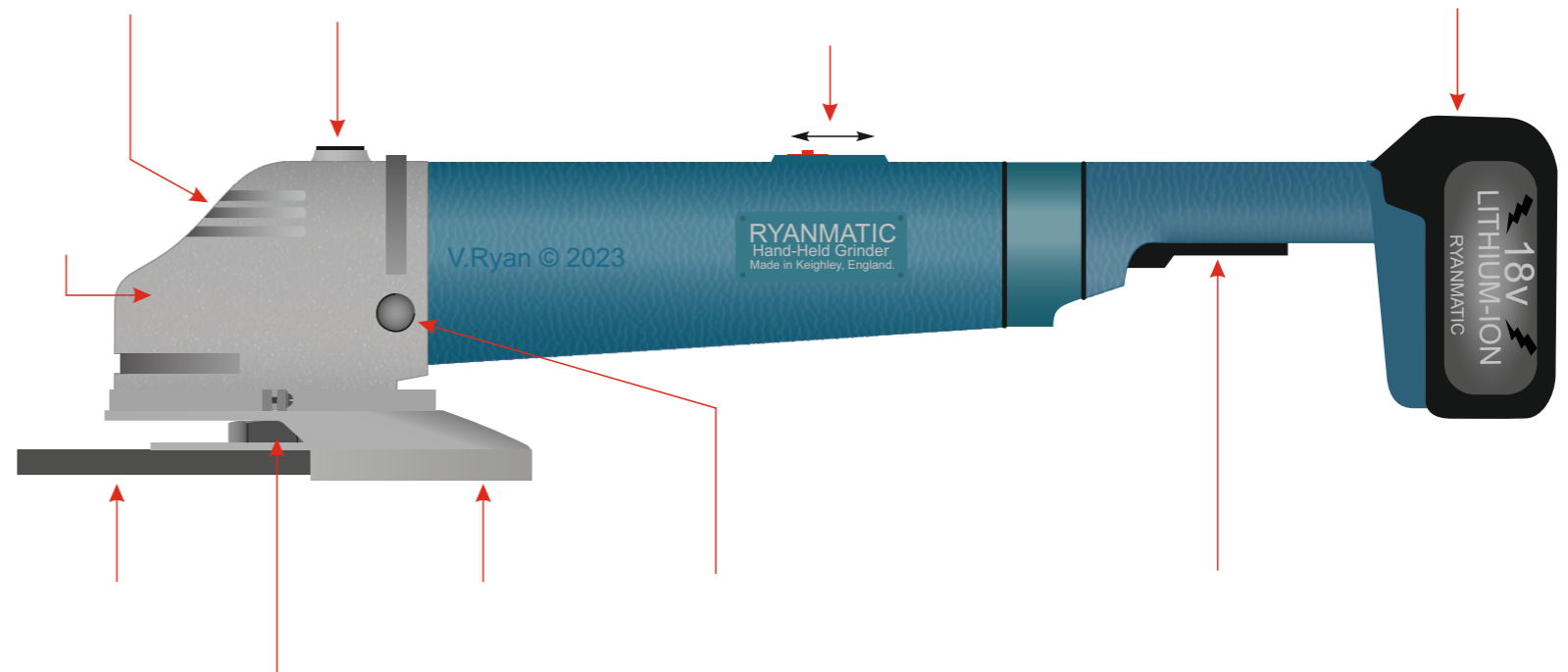

HELPFUL LINK: <https://www.technologystudent.com/mobapps/powertools1.pdf>